

HALLING

3700350
77736001

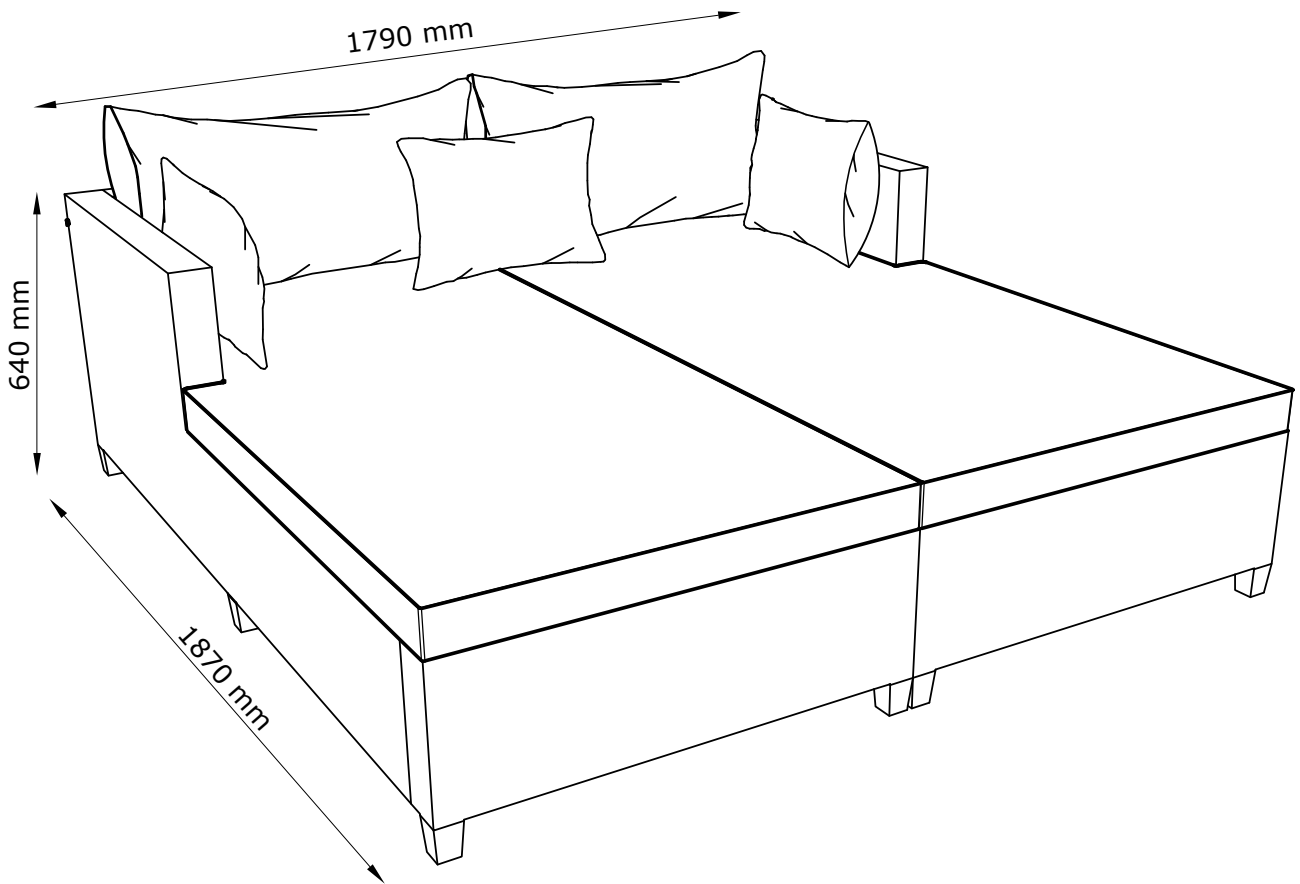

FR

Pensez à
donner ou recycler.



Association

ou



Magasin

ou





Déchèterie

<https://quefairedemesdechets.fr>



- GB** *IMPORTANT, RETAIN FOR FUTURE REFERENCE:
READ CAREFULLY.*
- DK** *VIGTIGT, GEMMES TIL SENERE BRUG: LÆS
OMHYGGELIGT.*
- DE** *WICHTIG, FÜR SPÄTERE BEZUGNAHME
AUFBEWAHREN: SORGFÄLTIG LESEN.*
- NO** *VIKTIG. MÅ OPPBEVARES FOR SENERE BRUK:
MÅ LESES NØYE.*
- SE** *VIKTIGT – SPARAS FÖR FRAMTIDA BRUK: LÄS
NOGA.*
- FI** *TÄRKEÄÄ, SÄILYTÄ MYÖHEMPÄÄ TARVETTA
VARTEN: LUE HUOLELLISESTI.*
- PL** *WAŻNE, ZACHOWAĆ NA PRZYSZŁOŚĆ:
PRZECZYTAĆ UWAŻNIE.*
- CZ** *DŮLEŽITÉ, USCHOVEJTE PRO POZDĚJŠÍ
POUŽITÍ: ČTĚTE POZORNĚ.*
- HU** *FONTOS, ŐRIZZE MEG A KÉSŐBBIEKRE:
OLVASSA EL FIGYELMESEN.*
- NL** *BELANGRIJK, BEWAREN VOOR TOEKOMSTIG
GEBRUIK: ZORGVULDIG LEZEN.*
- SK** *DÔLEŽITÉ, INFORMÁCIE SI ODLOŽTE NA
POUŽITIE V BUDÚCNOSTI: ČÍTAJTE POZORNE.*
- FR** *IMPORTANT, À CONSERVER POUR TOUTE
CONSULTATION ULTÉRIEURE: LIRE
ATTENTIVEMENT.*
- SI** *POMEMBNO, SHRANITE ZA POZNEJŠO
UPORABO: POZORNO PREBERITE.*
- HR** *VAŽNO, SPREMITI ZA BUDUĆU UPOTREBU:
POZORNO PROČITAJTE.*

- IT** *IMPORTANTE, CONSERVARE PER CONSULTAZIONI FUTURE: LEGGERE ATTENTAMENTE.*
- ES** *IMPORTANTE: CONSERVAR PARA FUTURAS CONSULTAS Y LEER DETENIDAMENTE.*
- BA** *VAŽNO, SAČUVAJTE ZA UBUDUĆE: PAŽLJIVO PROČITAJTE.*
- RS** *VAŽNO, SAČUVAJTE ZA BUDUĆU UPOTREBU: PAŽLJIVO PROČITAJTE.*
- UA** *УВАГА! ЗБЕРЕЖІТЬ ЦЮ ІНСТРУКЦІЮ ДЛЯ ВИКОРИСТАННЯ В МАЙБУТНЬОМУ. УВАЖНО ОЗНАЙОМТЕСЯ З ІНСТРУКЦІЄЮ.*
- RO** *IMPORTANT, PĂSTRAȚI PENTRU CONSULTARE ULTERIOARĂ: CITIȚI CU ATENȚIE.*
- BG** *ВАЖНО, ЗАПАЗЕТЕ ЗА БЪДЕЩА СПРАВКА: ПРОЧЕТЕТЕ ВНИМАТЕЛНО.*
- GR** *ΣΗΜΑΝΤΙΚΟ, ΦΥΛΑΞΤΕ ΓΙΑ ΜΕΛΛΟΝΤΙΚΗ ΑΝΑΦΟΡΑ: ΔΙΑΒΑΣΤΕ ΠΡΟΣΕΚΤΙΚΑ.*
- PT** *IMPORTANTE, CONSERVE PARA REFERÊNCIA FUTURA: LEIA COM ATENÇÃO.*
- RU** *ВАЖНАЯ ИНФОРМАЦИЯ, СОХРАНИТЕ ДЛЯ ДАЛЬНЕЙШЕГО ИСПОЛЬЗОВАНИЯ. ПРОЧИТЕ ВНИМАТЕЛЬНО.*
- TR** *ÖNEMLİ, GELECEKTE BAŞVURMAK İÇİN SAKLAYIN: DİKKATLE OKUYUN.*
- CN** *重要信息，请妥善保存供日后参考：请仔细阅读。*
- AR** *مهم، احتفظ به للرجوع إليه في المستقبل: اقرأ بعناية.*

EN581		
		
✓	✓	✗

GB Domestic use.

DK Husholdningsbrug.

DE Nutzung im Wohnbereich.

NO Privat bruk.

SE Hemmabruk.

FI Kotikäyttöön.

PL Do użytku na zewnątrz domu.

CZ Určeno pro domácí použití.

HU Lakásban való használatra.

NL Thuisgebruik.

SK Určené na domáce použitie.

FR Pour la maison.

SI Domača uporaba.

HR Za upotrebu u kućanstvu.

IT Uso domestico.

ES Uso doméstico.

BA Upotreba u domaćinstvu.

RS Za upotrebu u okviru domaćinstva.

UA Для домашнього використання.

RO Pentru uz casnic.

BG За употреба в домашни условия.

GR Για οικιακή χρήση.

PT Uso doméstico.

RU Для домашнего использования.

TR Ev içi kullanım.

CN 家庭用。



AR للاستخدام المنزلي.

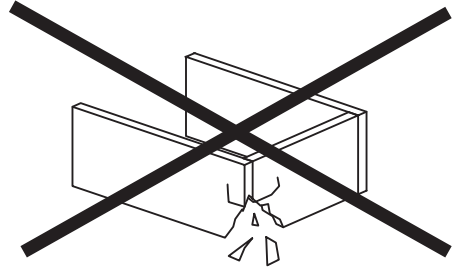
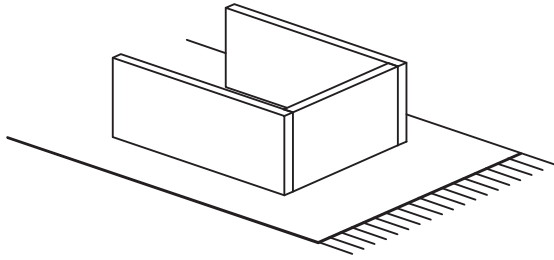

GB WARNING TO AVOID SCRATCHES!

In order to avoid scratching this furniture should be assembled on a soft layer - could be a rug.

DK ADVARSEL FOR AT FORHINDRE RIDSER!

For at forhindre ridser skal dette møbel samles på et blødt underlag, f.eks. et tæppe.

DE HINWEIS ZUR VERMEIDUNG VON KRATZERN!

Um Kratzer zu vermeiden, sollte dieses Möbelstück auf einer weichen Unterlage montiert werden (z. B. Teppich).

NO ADVARSEL FOR Å UNNGÅ RIPER!

For å unngå ripper må møbelet monteres på et mykt underlag, for eksempel et teppe.

SE VARNING OM HUR DU UNDVIKER REPOR!

För att undvika repor ska denna möbel monteras på ett mjukt underlag, exempelvis en matta.

FI VARO NAARMUJA!

Varo naarmuja ja kokoa tämä kaluste pehmeällä alustalla, esimerkiksi maton päällä.

PL OSTRZEŻENIE WS. USZKODZEŃ!

Aby uniknąć rys, ten mebel powinien być montowany, składany na miękkim podłożu, np. dywanie.

CZ VAROVÁNÍ TÝKAJÍC SE POŠKRÁBÁNÍ!

Aby nedošlo k poškrábání, sestavujte nábytek na měkkém podkladu – např. na koberci.

HU KARCOLÁSOK MEGELŐZÉSE – FIGYELEM!

A karcolások megelőzése érdekében a bútort puha felületen, például szőnyegen kell összeszerelni.

NL WAARSCHUWING OM KRASSEN TE VERMIJDEN!

Om te voorkomen dat dit meubel krassen vertoont, moet het gemonteerd worden op een zachte ondergrond - zoals een tapijt

SK VÝSTRAHA TÝKAJÚCA SA PREDCHÁDZANIA ŠKRABANCOM!

Aby sa predišlo škrabancom, tento nábytok by sa mal montovať na mäkkom podklade, napríklad na koberci.

FR AVERTISSEMENT POUR ÉVITER LES RAYURES!

Afin d'éviter les rayures, ce meuble doit être monté sur une surface souple (un tapis, par exemple).

SI KAKO PREPREČITI PRASKE!

Da bi se izognili praskam na pohoštvi, pohoštvo sestavite na mehki podlagi, npr. na preprogi.

HR UPOZORENJE O IZBJEGAVANJU OGREBOTINA!

Kako bi se izbjegle ogrebotine, ovaj proizvod potrebno je sastavljati na mekanoj površini - primjerice, na tepihu.

IT AVVERTENZA PER EVITARE I GRAFFI!

Per evitare i graffi, si raccomanda di montare questo mobile su una superficie morbida (come ad es. un tappeto).

ES ADVERTENCIA PARA EVITAR RAYADURAS!

Para no rayar este mueble, es aconsejable ensamblarlo sobre una superficie suave (posiblemente una alfombra).

BA UPOZORENJE ZA SPRJEČAVANJE NASTANKA OGREBOTINA!

Da bi se izbjegle ogrebotine na ovom namještaju, poželjno ga je sastaviti na mekoj podlozi - na primjer, tepihu.

RS UPOZORENJE ZA IZBEGAVANJE OGREBOTINA!

Da biste izbegli ogrebotine, ovaj nameštaj treba da sastavljate na mekoj podlozi - može prostirka.

UA ПОПЕРЕДЖЕННЯ ЩОДО ПОДРЯПИН!

Щоб уникнути подряпин, ці меблі слід збирати на м'якій поверхні, наприклад, на килимі.

RO ATENȚIONARE PENTRU EVITAREA ZGĂRIERII!

Pentru evitarea zgărierii, această piesă de mobilier trebuie să fie montată pe o suprafață moale, de exemplu, pe un covor.

BG ПРЕДУПРЕЖДЕНИЕ ЗА ИЗБЯГВАНЕ НА ДРАСКОТИНИ!

За да избегнете надраскване, тази мебел трябва да бъде сглобена на мека повърхност – например килим.

GR ΠΡΟΕΙΔΟΠΟΙΗΣΗ ΓΙΑ ΤΗΝ ΑΠΟΦΥΓΗ ΓΡΑΤΣΟΥΝΙΩΝ!

Για την αποφυγή γρατσουνιών, το έπιπλο θα πρέπει να συναρμολογηθεί σε μαλακή επιφάνεια, όπως για παράδειγμα πάνω σε ένα χαλί.

PT AVISO PARA EVITAR RISCOS!

Para evitar riscos, este móvel deve ser montado numa superfície macia (por exemplo, tapete).

RU ПРЕДУПРЕЖДЕНИЕ ОТНОСИТЕЛЬНО ЦАРАПИН!

Во избежание нанесения царапин, сборку этой мебели необходимо выполнять на мягкой поверхности, например на ковре.

TR ÇİZİLMELERİ ÖNLEMENE YÖNELİK UYARI!

Bu mobilyanın çizilmesini engellemek için montajını halı gibi yumuşak bir yüzeyin üzerinde yapın.

CN 防刮警告!

为了避免刮伤家具，应在地毯等软面上进行组装。

AR تحذير لتجنب الخدوش!

لتجنب الخدوش، ينبغي تجميع قطعة الأثاث هذه على طبقة ناعمة - قد تكون قطعة سجاد.

GB IMPORTANT!

It is important that any product which is assembled using any kind of screw is re-tightened 2 weeks after assembly, and once every 3 months - in order to assure stability through-out the lifespan of the product.

DK VIGTIGT!

Det er vigtigt, at alle produkter, der samles med alle former for skruer, efterspændes to uger efter samling samt hver tredje måned for at sikre, at produktet er stabilt i hele dets levetid.

DE WICHTIG!

Es ist wichtig, bei jedem mit Schrauben montierten Produkt diese 2 Wochen nach dem Zusammenbau sowie einmal alle 3 Monate wieder anzuziehen, um die Stabilität des Produkts über die gesamte Lebensdauer hinweg zu gewährleisten.

NO VIKTIG!

Det er viktig at alle produkter som monteres med skruer blir etterstrammet 2 uker etter montering, og hver 3. måned for å sikre stabiliteten gjennom hele produktets levetid.

SE VIKTIGT!

För alla produkter som monteras med skruv är det viktigt att dessa efterdras två veckor efter monteringen och därefter en gång var tredje månad. Detta för att säkerställa att produkten håller sig stabil under hela sin livslängd.

FI TÄRKEÄÄ!

On tärkeää, että kaikki ruuvien avulla koottavat tuotteet kiristetään uudelleen 2 viikkoa kokoamisen jälkeen ja aina 3 kuukauden välein, jotta tuote pysyy vakaana koko käyttöikänsä ajan.

PL WAŻNE!

Ważne jest, żeby każdy ze skręcanych produktów został ponownie dokręcony w ciągu 2 tygodni od montażu, a następnie sprawdzać co 3 miesiące czy śruby są dokręcone — w celu zapewnienia stabilności przez czas użytkowania produktu.

CZ DŮLEŽITÉ!

U každého výrobku, který se sestavuje pomocí jakýchkoli šroubků, je důležité dotáhnout šroubky 2 týdny po sestavení a potom každé 3 měsíce, aby byla zajištěna stabilita po celou dobu životnosti výrobku.

HU FONTOS!

Minden terméknél fontos, hogy bármilyen fajta csavarral is történi az összeszerelése, utána 2 héttel, majd 3 havi rendszerességgel szükséges a csavarok utánhúzása. Ezzel a termék teljes élettartamán keresztül biztosítható a stabilitása.

NL BELANGRIJK!

Het is belangrijk om elk product dat met om het even welk soort schroef wordt gemonteerd, twee weken na montage en om de drie maanden, opnieuw wordt vastgeschroefd, om de stabiliteit van het product tijdens de hele levensduur te verzekeren.

SK DŮLEŽITÉ!

Je dôležité, aby sa na akomkoľvek produkte, montovanom pomocou akýchkoľvek skrutiek, skrutky dotiahli po dvoch týždňoch od montáže, a jedenkrát v priebehu každých 3 mesiacov – tak sa zaručí stabilita počas celej životnosti produktu.

FR IMPORTANT!

Il est important que tout produit monté à l'aide de vis soit resserré 2 semaines après son montage, puis tous les 3 mois, afin de garantir sa stabilité durant tout son cycle de vie.

SI POMEMBNO!

Vsaki izdelek, ki ga sestavite z uporabo kakršnihkoli vijakov morate 2 tedna po sestavitvi ponovno pregledati in vijake po potrebi priviti. To ponovite vsake 3 mesece, da bi zagotovili stabilnost izdelka skozi njegovo celotno življenjsko dobo.

HR VAŽNO!

Važno je da se svi tipovi vijaka na bilo kojoj vrsti proizvoda koji se s pomoću njih sastavlja ponovno pritegnu 2 tjedna nakon sastavljanja te jednom svaka 3 mjeseca - kako bi se zajamčila stabilnost tijekom životnog vijeka proizvoda.

IT IMPORTANTE!

È importante in ogni prodotto montato con viti serrare ben strette le viti 2 settimane dopo il montaggio e poi ogni 3 mesi per garantire la sua stabilità durante tutta la durata del prodotto.

ES IMPORTANTE!

En el caso de los productos ensamblados, es importante volver a apretar los tornillos 2 semanas después del montaje y después cada 3 meses, para así preservar la estabilidad durante toda la vida útil del producto.

BA VAŽNO!

Za sve proizvode sa vijčanim vezama, potrebno je izvršiti pritezanje 2 sedmice nakon sklapanja i svaka 3 mjeseca nakon toga, kako bi se osigurala stabilnost tokom cijelog životnog vijeka proizvoda.

RS VAŽNO!

Važno je da svaki proizvod koji je sklopljen korišćenjem bilo kakvih šrafova bude ponovo pričvršćen 2 nedelje nakon sklapanja i jednom svaka 3 meseca - kako bi se obezbedila stabilnost tokom celog veka trajanja proizvoda.

UA УВАГА!

Майте на увазі, якщо у процесі монтажу продукту використовуються гвинти будь-якого типу, їх треба повторно затягнути через 2 тижні після монтажу, а потім кожні 3 місяці. Це необхідно для того, щоб забезпечити надійне використання продукту протягом терміну його служби.

RO IMPORTANT!

Este important ca şuruburile de orice tip, cu ajutorul cărora au fost montate produsele, să fie strânse din nou la 2 săptămâni după montare şi, apoi, o dată la 3 luni, pentru a se asigura stabilitatea de-a lungul duratei de viaţă a produsului.

BG ВАЖНО!

Важно е всеки продукт, който е сглобен с помощта на винтове, да бъде затегнат 2 седмици след сглобяването, и веднъж на всеки 3 месеца, за да се гарантира стабилност през цялото време на използване на продукта.

GR ΣΗΜΑΝΤΙΚΟ!

Για κάθε προϊόν που συναρμολογείται με βίδες είναι σημαντικό αυτές να ξανασφίγγονται 2 εβδομάδες μετά τη συναρμολόγηση και μία φορά κάθε 3 μήνες, για τη διασφάλιση της σταθερότητας σε όλη τη διάρκεια ζωής του προϊόντος.

PT AVISO IMPORTANTE!

É importante, em cada produto montado com parafusos, reapertar os mesmos 2 semanas após a montagem e uma vez a cada 3 meses para garantir a estabilidade do produto ao longo de toda a sua vida útil.

RU ВАЖНО!

В любом изделии, собранном с использованием винтов любого типа, необходимо через 2 недели после сборки и в дальнейшем каждые 3 месяца подтягивать винты, чтобы обеспечить прочность изделия в течение срока эксплуатации.

TR ÖNEMLİ!

Vida kullanılarak yapılan her türlü ürün montajı için montajdan 2 hafta sonra vidaların yeniden sıkıştırılması ve kullanım süresi boyunca ürün istikrarının sağlanması için de her 3 ayda bir vidaların sıkıştırılması önem arz eder.

CN 重要提示!

使用任何类型的螺钉组装的产品，必须在组装 2 周后重新拧紧，并且每 3 个月重新拧紧一次，以确保产品在整个使用期内结实稳固。

مهم! AR

من المهم إعادة إحكام ربط أي منتج تم تجميعه باستخدام أي نوع من البراغي بعد أسبوعين من التجميع، ومرة واحدة كل 3 أشهر - لضمان الثبات طوال عمر المنتج.

GB WARNING FOR SEATING FURNITURE!

Tested for 110 kg. per seat.

DK ADVARSEL VEDRØRENDE SIDDEMØBLER!

Testet for 110 kg. pr. siddeplads.

DE WARNUNG FÜR SITZMÖBEL!

Getestet für 110 kg je Sitz.

NO ADVARSEL FOR SITTEMØBEL!

Testet for 110 kg per sitteplass.

SE VARNING GÄLLANDE SITTMÖBLER!

Testad för 110 kg per sits.

FI ISTUINHUONEKALUA KOSKEVA VAROITUS!

Testattu 110 kg:lle istuinta kohden.

PL OSTRZEŻENIE DOTYCZĄCE SIEDZISKA!

Przetestowane obciążenie: 110 kg/siedzisko.

CZ VAROVÁNÍ PRO SEDACÍ NÁBYTEK!

Testováno na 110 kg na sedák.

HU ÜLŐBÚTORRAL KAPCSOLATOS FIGYELMEZTETÉS!

A vizsgálati terhelés ülésenként 110 kg volt.

NL WAARSCHUWING VOOR SITMEUBILAIR!

Getest voor 110 kg. per stoel.

SK VÝSTRAHA PRE SEDACÍ NÁBYTOK!

Testovaný na hmotnosť 110 kg na sedadlo.

FR AVERTISSEMENT POUR LE MOBILIER D'ASSISE!

Testé pour un poids de 110 kilos par assise.

SI OPOZORILO ZA SEDEŽNO POHIŠTVO!

Preskušeno za 110 kg/sedež.

HR UPOZORENJE O NAMJEŠTAJU ZA SJEDENJE!

Testiran je za težinu od 110 kg po sjedalu.

IT AVVERTENZA PER SEDUTE D'ARREDO!

Testate per 110 kg per seduta.

ES ¡ADVERTENCIA PARA ASIENTOS!

Probado para 110 kg por asiento.

BA UPOZORENJE ZA NAMJEŠTAJ ZA SJEDENJE!

Testirano za 110 kg po sjedištu.

RS UPOZORENJE VEZANO ZA NAMEŠTAJ ZA SEDENJE!

Testirano na 110 kg po mestu za sedenje.

UA ПОПЕРЕДЖЕННЯ ЩОДО ВИКОРИСТАННЯ МЕБЛІВ ДЛЯ СІДІННЯ.

Максимальне навантаження 110 кг на одне сидіння.

RO ATENȚIONARE PRIVIND MOBILIERUL PENTRU ȘEZUT!

Testat pentru 110 kg per piesă de mobilier pentru șezut.

BG ПРЕДУПРЕЖДЕНИЕ ЗА МЕБЕЛИ ЗА СЯДАНЕ!

Преминала изпитания за тегло 110 кг на седалка.

GR ΠΡΟΕΙΔΟΠΟΙΗΣΗ ΓΙΑ ΤΑ ΚΑΘΙΣΜΑΤΑ!

Δοκιμασμένα για 110 κιλά ανά θέση.

PT AVISO PARA CADEIRAS!

Testadas para 110 kg por cadeira.

RU ПРЕДУПРЕЖДЕНИЕ ДЛЯ МЯГКОЙ МЕБЕЛИ!

Максимально допустимый вес - 110 кг. на одно посадочное место.

TR BÜRO SANDALYELERİNE YÖNELİK UYARI!

110 kg için test edilmiştir.

CN 座椅警告信息!

测试重量为每个椅子 110 kg.

AR تحذير بشأن الأثاث المخصص للجلوس!
تم اختبار وزن 110 كغم للمقعد الواحد.



GB GENERAL INSTRUCTION FOR FURNITURE WITH FABRIC!

Wipe clean with a damp cloth. Use only clean water.

Dust and dirt can be vacuum cleaned or wiped with a clean soft cloth.

Do not use detergents, solvents or other chemicals on fabric as this may cause discoloration.

However, certain removable fabrics may be washed, but in such cases there will ALWAYS be a washing instruction on the fabric.

DK GENEREL VEJLEDNING TIL MØBLER MED STOF!

Rengøres med en fugtig klud. Anvend kun rent vand.

Støv og snavs støvsuges eller tørres af med en ren blød klud.

Brug ikke vaskemidler, opløsningsmidler eller andre kemikalier på stof, da dette kan medføre misfarvninger.

Visse aftagelige stoffer kan dog vaskes, men der vil i sådanne tilfælde ALLTID være en vaskeanvisning på stoffet.

DE ALLGEMEINE PFLEGEHINWEISE FÜR POLSTERMÖBEL!

Mit einem feuchten Tuch abwischen. Nur sauberes Wasser verwenden.

Staub und Schmutz können gesaugt oder mit einem sauberen, weichen Tuch abgewischt werden.

Keine Reinigungsmittel, Lösungsmittel oder andere Chemikalien auf dem Gewebe verwenden, da dies zu Verfärbungen führen kann.

Einige abnehmbare Bezüge können gewaschen werden. In dem Fall befindet sich IMMER eine Waschanleitung auf dem Stoff.

NO GENERELL INSTRUKSJON FOR MØBLER MED STOFF!

Tørk av med en fuktig klut. Bruk bare rent vann.

Støv og smuss kan støvsuges eller tørkes av med en ren, myk klut.

Ikke bruk vaskemidler, løsemidler eller andre kjemikalier på stoffet. Det kan føre til misfarging.

Enkelte avtakbare stofftrekk kan imidlertid vaskes. I så fall er det ALLTID en vaskeanvisning på stoffet.

SE ALLMÄNNA INSTRUKTIONER FÖR MÖBLER MED TYG!

Torka rent med en fuktig trasa. Använd endast rent vatten.

Damm och smuts kan dammsugas upp eller torkas bort med en ren, mjuk trasa.

Undvik att använda rengöringsmedel, lösningsmedel eller andra kemikalier på tyg eftersom det kan orsaka missfärgningar.

Vissa avtagbara tyger kan dock tvättas, men i sådana fall sitter det ALLTID tvättanvisningar på tyget.

FI YLEISOHJEET KANKAALLA VERHOILTUJA HUONEKALUJA VARTEN!

Pyyhi puhtaaksi kostealla liinalla. Käytä vain puhdasta vettä.

Pöly ja lika voidaan imuroida tai pyyhkiä puhtaalla, pehmeällä liinalla.

Älä käytä puhdistusaineita, liuottimia tai muita kemikaaleja kankaaseen, sillä ne voivat aiheuttaa värvirvkeitä.

Tietyt irrotettavat kankaat voidaan kuitenkin pestä, mutta sellaisissa tapauksissa kankaassa on AINA pesuohjeet.

PL OGÓLNA INSTRUKCJA KORZYSTANIA Z MEBLI TAPICEROWANYCH!

Czyścić, przecierając wilgotną ściereczką. Stosować tylko wodę.

Kurz i zanieczyszczenia można usuwać odkurzaczem lub przecierając tapicerkę czystą, miękką szmatką.

Na tkaninę nie nakładać detergentów, rozpuszczalników ani innych chemikaliów, ponieważ mogą one spowodować odbarwienie.

Niektóre zdejmowane pokrowce można prać, ale w takich przypadkach ZAWSZE stosować się do instrukcji prania podanych na metce.

CZ OBECNÉ POKYNY PRO NÁBYTEK S TEXTILEM!

Čistěte otřením navlhčeným hadříkem. Používejte pouze čistou vodu.

Prach a nečistotu můžete vysát nebo otřít čistým měkkým hadříkem.

Na textil nepoužívejte čisticí prostředky, rozpouštědla či jiné chemické látky, protože by mohly způsobit odbarvení.

Některé snímatelné textilní části je možno prát, avšak v každém případě VŽDY podle pokynů pro praní uvedených na textilu.

HU ÁLTALÁNOS ÚTMUTATÓ SZÖVETTEL ELLÁTOTT BÚTOROKHOZ!

Törölje tisztára nedves ruhával. Csak tiszta vizet használjon.

A port és szennyeződést felporszívózhatja vagy letörölheti tiszta, puha ruhával.

Ne használjon mosószert, oldószert vagy más vegyi anyagot a szöveten, mivel azok elszíneződést okozhatnak.

Ennek ellenére bizonyos leszedhető szövetek moshatók, de ilyen esetben a szöveten MINDIG feltüntetjük a mosásra vonatkozó útmutatót.

NL ALGEMENE INSTRUCTIE VOOR MEUBEL EN STOF!

Reinig met een vochtige doek. Alleen schoon water gebruiken.

Stof en vuil kan worden gestofzuigd of met een schone, zachte doek worden afgeveegd.

Gebruik geen reinigingsmiddelen, oplosmiddelen of andere chemische middelen op stof omdat dit verkleuring kan veroorzaken.

Bepaalde afneembare stoffen kunnen wel gewassen worden, maar in dergelijke gevallen staat er ALTIJD een wasvoorschrift op de stof.

SK VŠEOBECNÉ POKYNY K NÁBYTKU S PRVKAMI LÁTKY!

Utrite dočista navlhčenou handričkou. Používajte len čistú vodu.

Prach a nečistoty môžete povysávať alebo utrieť čistou jemnou handričkou.

Na látku nepoužívajte saponáty, rozpúšťadlá ani iné chemikálie, keďže by to mohlo spôsobiť zmenu farby.

Niektoré odnímateľné textilné časti je však možné vyprať, no v týchto prípadoch VŽDY podľa pokynov na pranie.

FR INSTRUCTIONS GÉNÉRALES POUR LE MOBILIER EN TISSU!

Nettoyez à l'aide d'un chiffon humide. N'utilisez que de l'eau claire.

La poussière et la saleté peuvent être aspirées ou essuyées à l'aide d'un chiffon doux et propre.

N'utilisez aucun détergent, solvant ou autre produit chimique sur le tissu, car ceci pourrait le décolorer.

Cependant, certains tissus amovibles peuvent être lavés, mais dans ce cas le tissu comportera TOUJOURS des instructions de lavage.

SI SPLOŠNA NAVODILA ZA POHIŠTVO S TKANINO!

Obrišite z vlažno krpo. Uporabljajte le čisto vodo.

Prah in umazanijo je mogoče posesati ali obrisati s čisto mehko krpo.

Za čiščenje tkanine ne uporabljajte detergentov, topil ali drugih kemikalij, ki lahko povzročijo njeno obledelost.

Nekateri odstranjivi tkanini je sicer mogoče oprati, vendar so v takih primerih na tkanini VEDNO na voljo navodila za pranje.

HR OPĆE UPUTE ZA NAMJEŠTAJ S TKANINOM!

Očistite vlažnom krpom. Upotrebljavajte samo čistu vodu.

Prašina i prljavština mogu se očistiti usisivačem ili obrisati čistom mekanom krpom.

Nemojte upotrebljavati deterdžente, otapala ili druge kemikalije na tkanini jer mogu izbljediti boju.

Neke uklonjive tkanine ipak se smiju prati, no u tim slučajevima na tkanini će se UVIJEK nalaziti uputa za pranje.

IT ISTRUZIONI GENERALI PER MOBILI CON TESSUTO!

Pulire con un panno umido. Utilizzare solo acqua pulita.

La polvere e lo sporco possono essere aspirati o puliti con un panno morbido pulito.

Non usare detersivi, solventi o altre sostanze chimiche sul tessuto perché possono scolorirlo.

Tuttavia alcuni rivestimenti in tessuto sfoderabili possono essere lavati, ma in questi casi sul tessuto sono SEMPRE presenti le istruzioni di lavaggio.

ES INSTRUCCIONES GENERALES PARA MOBILIARIO CON TEJIDO!

Limpiar con un paño húmedo. Usar solo agua limpia.

Retirar el polvo y la suciedad con un aspirador o limpiarlo con un paño limpio y suave.

No usar detergentes, disolventes ni otros productos químicos con el tejido ya que podrían decolorarlo.

Sin embargo, algunos tejidos extraíbles pueden ser lavados, en este caso siempre encontraremos unas instrucciones de lavado en el propio tejido.

BA OPŠTA UPUTSTVA ZA NAMJEŠTAJ OD TKANINE!

Obrisati vlažnom krpom. Koristiti samo čistu vodu.

Prašina i prljavština mogu se usisati ili obrisati čistom mekom krpom.

Ne koristite deterdžente, rastvarače ili druge hemikalije na tkanini, jer time možete izazvati gubitak boje.

Međutim, neke odvojive tkanine se mogu prati, ali u takvim slučajevima će na tkanini UVJEK biti uputstva za pranje.

RS OPŠTA UPUTSTVA ZA NAMEŠTAJ SA TKANINOM!

Obrišite vlažnom krpom. Koristite samo čistu vodu.

Prašinu i prljavštinu možete da usisate ili obrišete čistom mekom krpom.

Nemojte da koristite deterdžente, rastvarače ili druge hemikalije na tkanini jer tako može da dođe do promene boje.

Međutim, neke tkanine koje mogu da se uklone mogu i da se peru, ali tu tim slučajevima na tkanini UVEK postoji uputstvo za pranje.

UA ЗАГАЛЬНІ ІНСТРУКЦІЇ ДЛЯ МЕБЛІВ З ОББИВКОЮ З ТКАНИНИ!

Очищайте за допомогою вологої ганчірки. Використовуйте тільки чисту воду.

Пил і бруд можна видалити за допомогою пилососа або чистої м'якої тканини.

Не використовуйте миючі засоби, розчинники або інші хімічні речовини на текстильних поверхнях, оскільки це може спричинити знебарвлення тканини.

Деякі знімні частини з тканини можна прати, але в таких випадках на матерії ЗАВЖДИ буде присутня інструкція з прання.

RO INSTRUCȚIUNI GENERALE PENTRU MOBILIER CU ȚESĂTURĂ!

Curățați prin ștergere cu o lavetă umedă. Utilizați numai apă curată.

Praful și murdăria pot fi curățate cu aspiratorul sau șterse cu o cârpă moale curată.

Nu utilizați detergenți, solvenți sau alte substanțe chimice pe țesătură deoarece acestea pot decolora materialul.

Cu toate acestea, anumite țesături detașabile pot fi spălate, dar în astfel de cazuri vor exista ÎNTOTDEAUNA instrucțiuni de spălare pe țesătură.

BG ОБЩА ИНСТРУКЦИЯ ЗА МЕБЕЛИ С ПЛАТ!

Избършете с влажна кърпа. Използвайте само чиста вода.

Прах и мръсотия могат да се почистват с прахосмукачка или да се избършат с чиста мека кърпа.

Не прилагайте почистващи препарати, разтворители или други химически средства върху плата, тъй като това може да доведе до обезцветяване.

Някои свалящи се платнени калъфи могат да бъдат прани, но в този случай ЗАВЪЛЖИТЕЛНО ще има инструкция за пране на тъканта.

GR ΓΕΝΙΚΕΣ ΟΔΗΓΙΕΣ ΓΙΑ ΕΠΙΠΛΑ ΜΕ ΥΦΑΣΜΑ!

Σκουπίζετε με ένα υγρό πανί. Χρησιμοποιείτε μόνο καθαρό νερό.

Η σκόνη μπορεί να καθαριστεί με ηλεκτρική σκούπα ή ένα καθαρό μαλακό πανί.

Μην χρησιμοποιείτε απορροπαντικά, διαλύτες ή άλλες χημικές ουσίες, καθώς μπορεί να προκληθεί αποχρωματισμός.

Ωστόσο, ορισμένα αφαιρούμενα υφάσματα μπορούν να πλυθούν, αλλά σε αυτές περιπτώσεις θα υπάρχει ΠΑΝΤΑ στο ύφασμα σχετική οδηγία πλυσίματος.

PT INSTRUÇÕES GERAIS DE CUIDADO PARA MÓVEIS ESTOFADOS!

Limpar com um pano húmido. Usar apenas água limpa.

Poeira e sujeira podem ser aspiradas ou limpas com um pano limpo e macio.

Não usar detergentes, solventes ou outros produtos químicos no tecido, pode causar descoloração.

Algumas capas removíveis podem ser lavadas. Nesse caso, SEMPRE existem instruções de lavagem no tecido.

RU ОБЩИЕ УКАЗАНИЯ ПО УХОДУ ЗА МЕБЕЛЬЮ С ОТДЕЛКОЙ ИЗ ТКАНИ!

Очистите изделие чистой влажной тряпкой. Используйте только чистую воду.

Пыль и грязь можно удалять пылесосом или чистой мягкой тряпкой.

Не наносите моющие средства, растворители или другие химические вещества на ткань, поскольку они могут привести к вымыванию цвета.

Некоторые съёмные элементы из ткани можно стирать. В таких случаях к ткани ОБЯЗАТЕЛЬНО прилагается инструкция по стирке.

TR KUMAŞ MOBİLYALAR İÇİN GENEL TALİMATLAR!

Nemli bir bezle silerek temizleyin. Yalnızca temiz su kullanın.

Toz ve kir elektrikli süpürgesi ile veya temiz yumuşak bir bezle temizlenebilir.

Renklerin solmasına yol açabileceği için kumaşa deterjan, solvent veya başka kimyasal madde kullanmayın.

Bazı sökülebilir kumaşlar yıkanabilir ancak bu durumda kumaşa MUTLAKA bir yıkama talimatı olacaktır.

CN 布艺家具的一般说明!

请用湿布擦拭。只能使用干净水。

灰尘和脏污可利用真空清洁或用洁净的软布擦拭。

请勿在布料上使用清洗剂、溶剂或其他化学产品，以免布料褪色。

某些可拆卸的布料可以清洗，但必须始终遵循布料的洗涤说明。

AR إرشادات عامة للأثاث المشتمل على قماش!

ينبغي المسح بقطعة قماش مبللة. لا تستخدم سوى ماء نظيف.

يمكن تنظيفه من الغبار والأوساخ بالمكنسة الكهربائية أو المسح بقطعة قماش ناعمة ونظيفة.

لا تستخدم المنظفات أو المذيبات أو غيرها من المواد الكيميائية على القماش، فقد يتسبب ذلك في تغير لونه.

ومع ذلك، يمكن غسل أقمشة معينة قابلة للإزالة، ولكن في مثل هذه الحالات، ستجد دائمًا إرشادات الغسل على القماش.

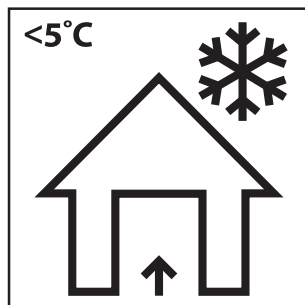

GB Storage of garden furniture and garden products.

The best way to extend the life of your garden product is to clean it regularly and before storage.

Store the product in a cool, dry and ventilated place indoors or covered when the temperature is below 5 degrees Celsius or when weather conditions require it.

DK Opbevaring af havemøbler og haveprodukter.

Den bedste måde at forlænge dit haveprodukts levetid på, er at rengøre det regelmæssigt og før opbevaring.

Opbevar produktet på et køligt, tørt og ventileret sted indendørs eller tildækket, når temperaturen er under 5 grader celsius eller når vejrforholdene kræver det.

DE Lagerung von Gartenmöbeln und Gartenprodukten.

Die beste Möglichkeit, die Lebensdauer deines Gartenprodukts zu verlängern, besteht darin, es regelmäßig und vor der Lagerung zu reinigen.

Lagere das Produkt an einem kühlen, trockenen und belüfteten Ort im Haus oder überdacht, wenn die Temperatur unter 5 Grad Celsius liegt oder die Wetterbedingungen es erfordern.

NO Oppbevaring av hagemøbler og hageprodukter.

Den beste måten å forleng levetiden til hageproduktet ditt er å rengjøre det både regelmessig og før lagring.

Oppbevar produktet tildekket eller på et kjølig, tørt og ventilert sted innendørs når temperaturen er under 5 grader Celsius eller når værforholdene krever det.

SE Förvaring av trädgårdsmöbler och trädgårdsvaror.

Det bästa sättet att förlänga livslängden på din trädgårdsvara är att rengöra den regelbundet och före förvaring.

Förvara varan på en sval, torr och ventilerad plats inomhus eller täckt när temperaturen är under 5 grader Celsius eller när väderförhållandena kräver det.

FI Puutarhatsuhteiden ja kalusteiden säilytys ja varastoiminen.

Paras tapa pidentää puutarhatsuhteiden ikää, on puhdistaa ne säännöllisesti ja ennen varastoimista.

Säilytä tuote viileässä, kuivassa ja ilmastoidussa sisätilassa tai peitettynä, kun lämpötila on alle 5°C tai kun sääolot sitä vaativat.

PL Przechowywanie mebli ogrodowych i produktów ogrodowych.

Najlepszym sposobem na przedłużenie żywotności produktu ogrodowego jest jego regularne czyszczenie przed przechowywaniem.

Produkt należy przechowywać w chłodnym, suchym i wentylowanym miejscu w pomieszczeniu lub pod przykryciem, gdy temperatura jest niższa niż 5 stopni Celsjusza lub gdy wymagają tego warunki pogodowe.

CZ Uskladnění zahradního nábytku a zahradních výrobků.

Nejllepší způsob, jakým prodloužíte životnost svých výrobků pro zahradu, je pravidelné čištění a důkladné čištění před uložením.

Výrobky skladujte na chladném, suchém a větraném místě v interiéru, pokud je teplota nižší než 5 °C nebo pokud to vyžadují povětrnostní podmínky, použijte potahy a výrobek zakryjte.

HU Kerti bútorok és kerti termékek tárolása.

Kerti termékeinek élettartamát a legjobban úgy hosszabbíthatja meg, ha az eltárolást megelőzően, valamint használat közben is rendszeresen tisztítja.

Tárolja a terméket hűvös, száraz és szellőző helyen beltéren, vagy lefedve, ha a hőmérséklet 5 Celsius-fok alatt van, vagy amikor az időjárási körülmények ezt megkövetelik.

NL Opbergen van tuinmeubelen en tuinproducten.

De beste manier om de levensduur van je tuinproduct te verlengen is door het regelmatig schoon te maken en op te bergen.

Bewaar het artikel binnen op een koele, droge en geventileerde plaats wanneer de temperatuur lager is dan 5 graden celsius of wanneer de weersomstandigheden dit vereisen.

SK Uskladnenie záhradného nábytku a záhradných výrobkov.

Najlepší spôsob, akým predĺžiť životnosť vašich záhradných výrobkov, je ich pravidelné čistenie a dôkladné vyčistenie pred uskladnením.

Keď teplota klesne pod 5 stupňov Celzia alebo keď si to vyžadujú poveternostné podmienky, uskladnite výrobok vo vnútri alebo prikrýť na chladnom, suchom a vetranom mieste.

FR Rangement du mobilier de jardin et des articles de jardin.

Afin de prolonger la durée de vie de votre article de jardin au maximum, il est conseillé de le nettoyer régulièrement, notamment avant de le ranger.

Conservez le produit dans un endroit frais, sec et ventilé à l'intérieur ou couvert quand la température est inférieure à 5 degrés Celsius ou quand les conditions météorologiques l'exigent.

SI Skladiščenje vrtnega pohištva in vrtnih izdelkov.

Najboljši način za podaljšanje življenjske dobe vašega vrtnega izdelka je, da ga čistite redno in pred shranjevanjem.

Izdelek shranjujte na hladnem, suhem in zračnem prostoru v notranjosti ali pokrito, ko je temperatura nižja od 5 stopinj Celzija ali ko vremenske razmere to zahtevajo.

HR Skladištenje vrtnog namještaja i vrtnih proizvoda.

Najbolji način da produžite vijek trajanja svog vrtnog proizvoda je da ga čistite redovito, te prije skladištenja.

Proizvod čuvajte na hladnom, suhom i prozračenom mjestu u zatvorenom prostoru ili pokrivenog kada je temperatura ispod 5 stupnjeva Celzijusa ili kada to zahtijevaju vremenski uvjeti.

IT Riporre i mobili e gli articoli da giardino.

Il miglior modo per prolungare la vita del tuo articolo da giardino è di pulirlo regolarmente prima di riporlo.

Riporre l'articolo in un luogo al chiuso fresco, asciutto e ventilato oppure tenerlo all'esterno e coprirlo quando le temperature scendono sotto ai -5°C o nel caso in cui le condizioni meteorologiche lo richiedano.

ES Almacenaje de muebles de jardín y artículos de jardín.

La mejor forma de prolongar la vida de tu artículo de jardín es limpiarlo de forma habitual y antes de guardarlo.

Guarda el artículo en un lugar interior que sea fresco, seco y ventilado, o cubierto, cuando la temperatura baje de 5 grados centígrados o cuando las condiciones climatológicas lo requieran.

BA Odlaganje baštenskog namještaja i baštenskih proizvoda.

Najbolji način da produžite životni vijek vašeg baštenskog proizvoda je da ga čistite redovno kao i pr*ije odlaganja.

Čuvajte proizvod na hladnom, suhom i provjetrenom mjestu u zatvorenom prostoru ili pokrivenog kada je temperatura ispod 5 stepeni Celzijusa ili kada vremenski uslovi to zahtijevaju.

RS Odlaganje baštenskog nameštaja i baštenskih proizvoda.

Najbolji način da produžite životni vek vašeg baštenskog proizvoda je da ga čistite redovno kao i pre odlaganja.

Čuvajte proizvod na hladnom, suvom i provetrenom mestu u zatvorenom prostoru ili pokrivenog kada je temperatura ispod 5 stepeni Celzijusa ili kada vremenski uslovi to zahtevaju.

UA Зберігання садових меблів та товарів для саду.

Найкращий спосіб продовжити термін використання ваших садових меблів — регулярно чистити їх перед зберіганням.

Зберігайте їх у прохолодному, сухому та провітрюваному місці в закритому приміщенні або у чохлі, якщо температура нижче 5 градусів за Цельсієм або якщо цього вимагають погодні умови.

RO Depozitarea mobilierului de grădină și a articolelor de grădină.

Cea mai bună modalitate de a prelungi durata de viață a articolelor de grădină este curățarea acestora în mod regulat și înainte de depozitare.

Depozitați articolele într-un loc răcoros, uscat și ventilat în interior sau acoperit atunci când temperatura este sub 5 grade Celsius sau când condițiile meteorologice o impun.

BG Съхраняване на градински мебели и градински артикули.

Най-добрият начин да удължите живота на градинските си артикули е да ги почиствате редовно и преди да ги приберете за съхранение.

Съхранявайте артикулите на хладно, сухо и проветриво място на закрито или ги покрийте, когато температурата е под 5 градуса по Целзий или когато атмосферните условия го изискват.

GR Αποθήκευση επίπλων κήπου και προϊόντων κήπου.

Ο καλύτερος τρόπος για να επεκτείνετε τη ζωή ενός προϊόντος κήπου σας είναι να το καθαρίζετε τακτικά και πριν το αποθηκεύσετε.

Αποθηκεύστε το προϊόν σε ένα δροσερό, ξηρό και αεριζόμενο μέρος σε εσωτερικό χώρο ή σε μέρος καλυμμένο, όταν η θερμοκρασία είναι κάτω από 5 βαθμούς Κελσίου ή όταν οι καιρικές συνθήκες το επιτρέπουν.

PT Armazenar móveis de jardim e artigos de jardim.

A melhor forma de prolongar a vida útil do seu artigo de jardim é limpá-lo regularmente e também antes de o guardar.

Armazene o artigo em local fresco, seco e ventilado no interior ou coberto quando a temperatura for inferior a 5 graus Celsius, ou quando as características atmosféricas assim o exigirem.

RU Хранение садовой мебели и садовых изделий.

Лучшим способом продления срока службы ваших садовых изделий является их регулярная очистка перед хранением.

Храните изделия в прохладном, сухом и проветриваемом помещении или в чехле, если температура ниже 5 градусов Цельсия или этого требуют погодные условия.

TR Bahçe mobilyaları ve bahçe ürünlerinin depolanması.

Bahçe ürünlerinizin ömrünü uzatmanın en iyi yolu, düzenli olarak ve kaldırmadan hemen önce temizlemektir.

Ürünü serin, kuru ve hava alan bir yerde, iç mekanda veya sıcaklığın 5 derece altında olduğu gibi durumlarda üstü kapalı bir şekilde saklayın.

CN 庭院家具和庭院产品的存放.

延长庭院产品使用寿命的最佳方式是定期清洁，在存放前清洁。

当温度低于 5 摄氏度或考虑到天气情况时，请将本产品存放在阴凉、干燥、通风的室内或罩上外罩。

AR تخزين أثاث الحدائق ومنتجاتها.

أفضل طريقة لإطالة عمر منتج الحديقة لديك تنظيفه بانتظام وقبل التخزين.

قم بتخزين المنتج في مكان مغلق بارد وجاف ويتمتع بالتهوية أو قم بتغطية المنتج عندما تنخفض درجة الحرارة عن 5 درجات مئوية أو عندما تقتضي الظروف الجوية ذلك.



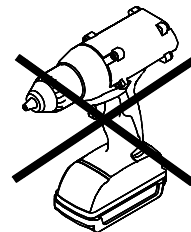

A x 8

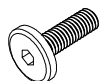

M6x15 mm

B x 40

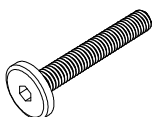

M6x40 mm

C x 12

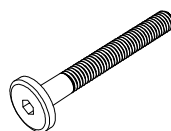

M6x55 mm

D x 2

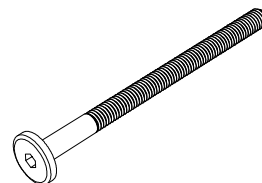

M6x110 mm

E x 42



Ø6/Ø14 mm

F x 12

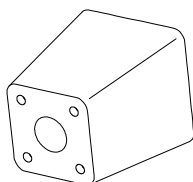

45x45x65 mm

G x 3



60x40x30 mm

H x 3

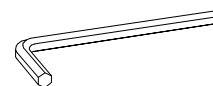

4 mm

J x 1

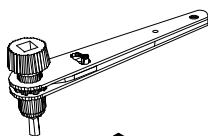

4 mm

K x 1



4 mm

L x 2



Ø12/Ø16 mm

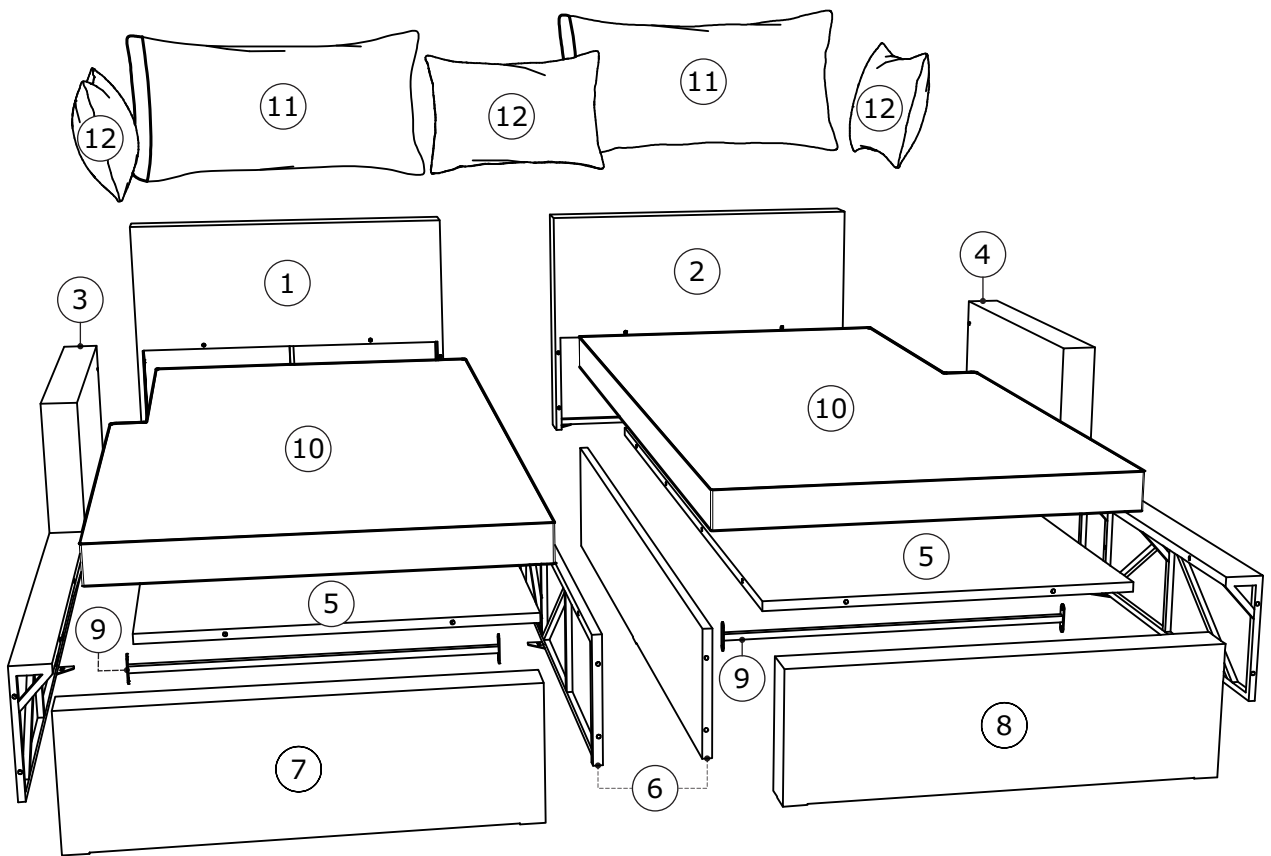

BOX 1/2:

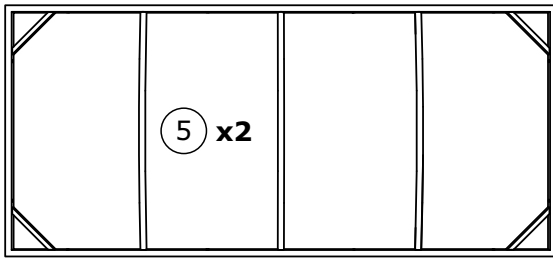

1690x770x70 mm

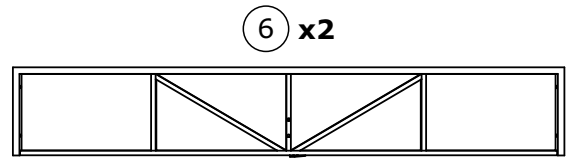

1690x280x50 mm

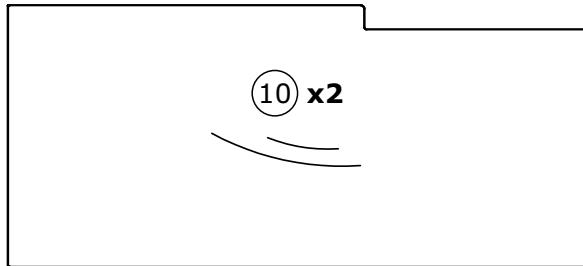

1770x890x80 mm

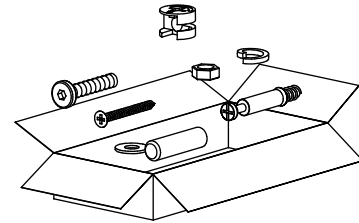

BOX 2/2:

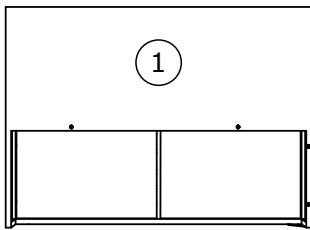

800x580x90 mm

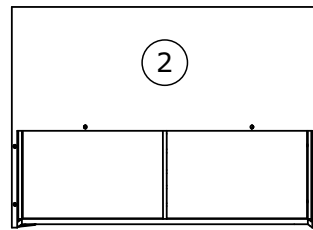

800x580x90 mm

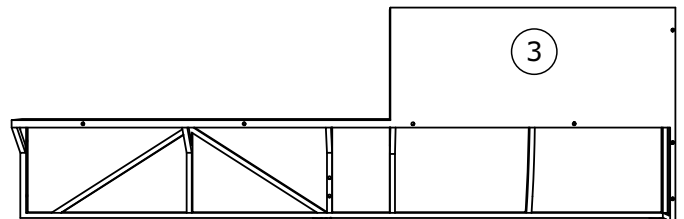

1780x580x90 mm

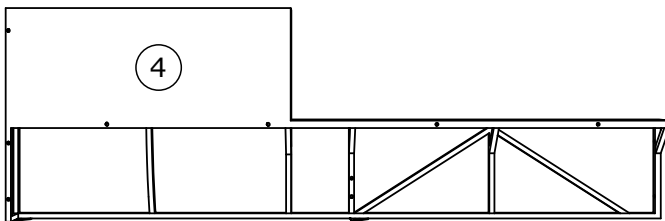

1780x580x90 mm

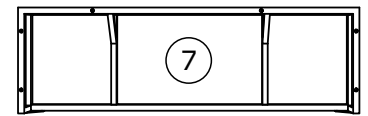

890x280x90 mm

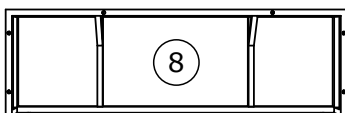

890x280x90 mm

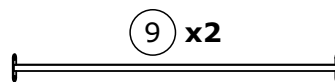

842x70x20 mm

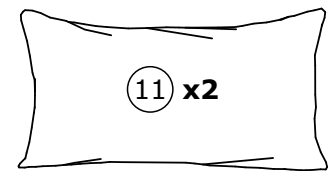



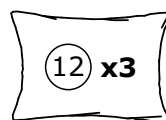

780x380x210 mm

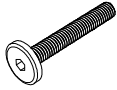
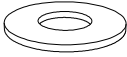
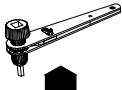

410x410x160 mm

1



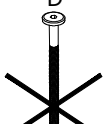

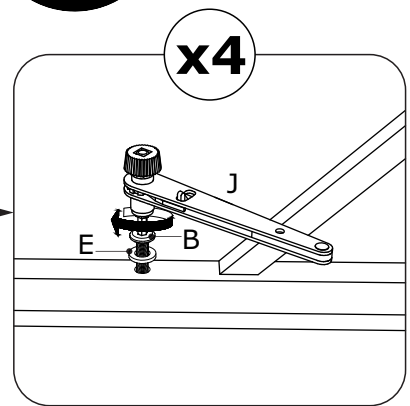
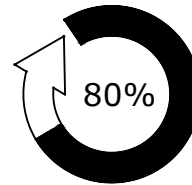
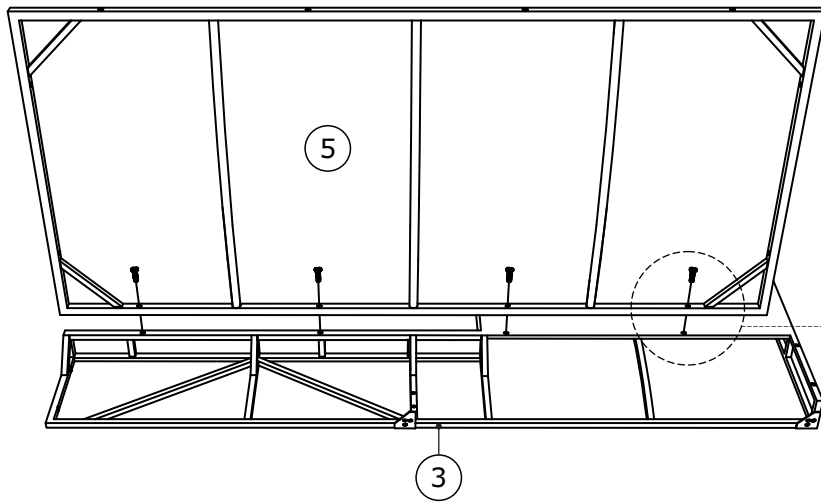
B x 4  M6x40 mm	E x 4  Ø6/Ø14 mm	J x 1  4 mm	
--	---	--	--

	A  M6x15 mm	B  M6x40 mm	C  M6x55 mm	D  M6x110 mm
---	--	--	--	---

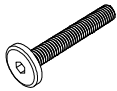
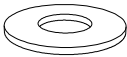
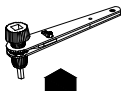

2



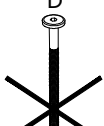

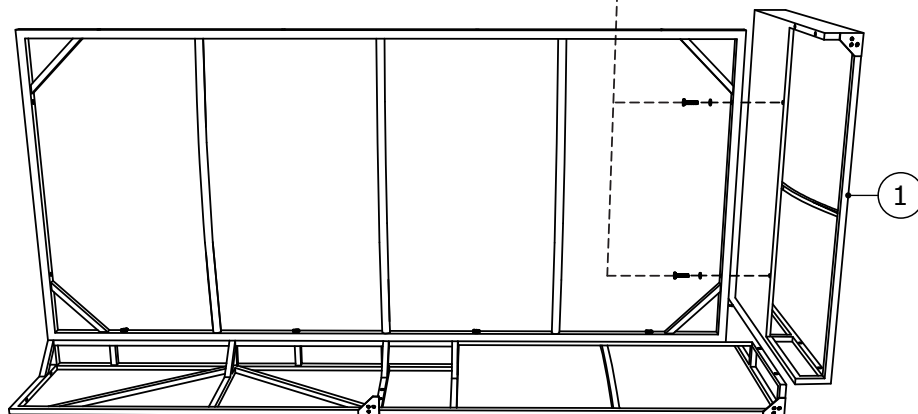
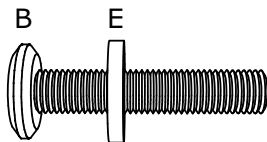
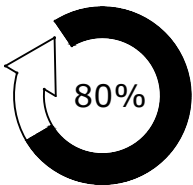
B x 2  M6x40 mm	E x 2  Ø6/Ø14 mm	J x 1  4 mm	
--	---	--	--

	A  M6x15 mm	B  M6x40 mm	C  M6x55 mm	D  M6x110 mm
---	--	--	--	---

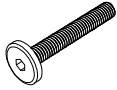
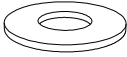
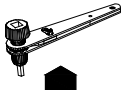

3



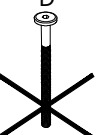

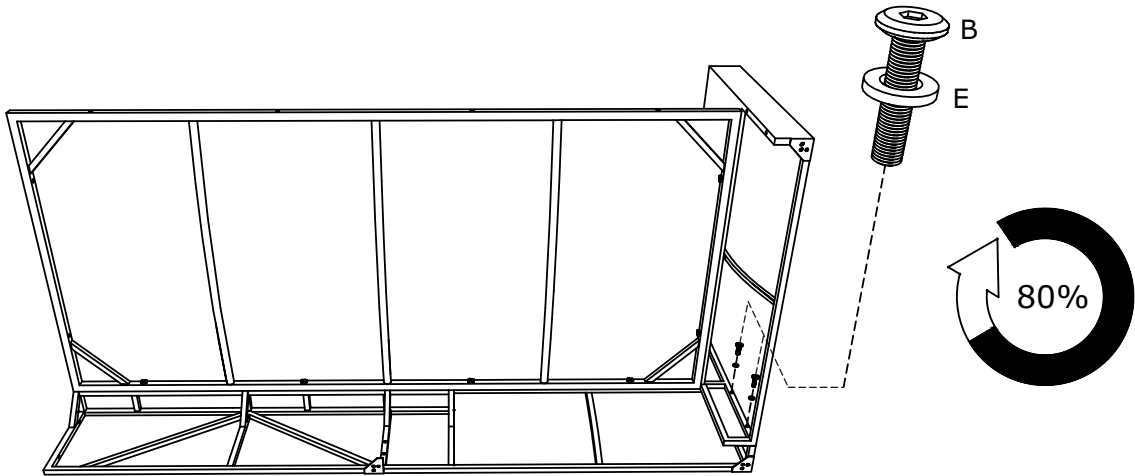
B x 2  M6x40 mm	E x 2  Ø6/Ø14 mm	J x 1  4 mm	
--	---	--	--

A 	B  M6x15 mm	B  M6x40 mm	C  M6x55 mm	D  M6x110 mm
--	--	--	--	---

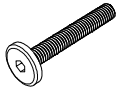
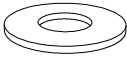
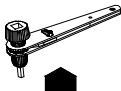

4

B x 5  M6x40 mm	E x 5  Ø6/Ø14 mm	J x 1  4 mm	
--	---	--	--

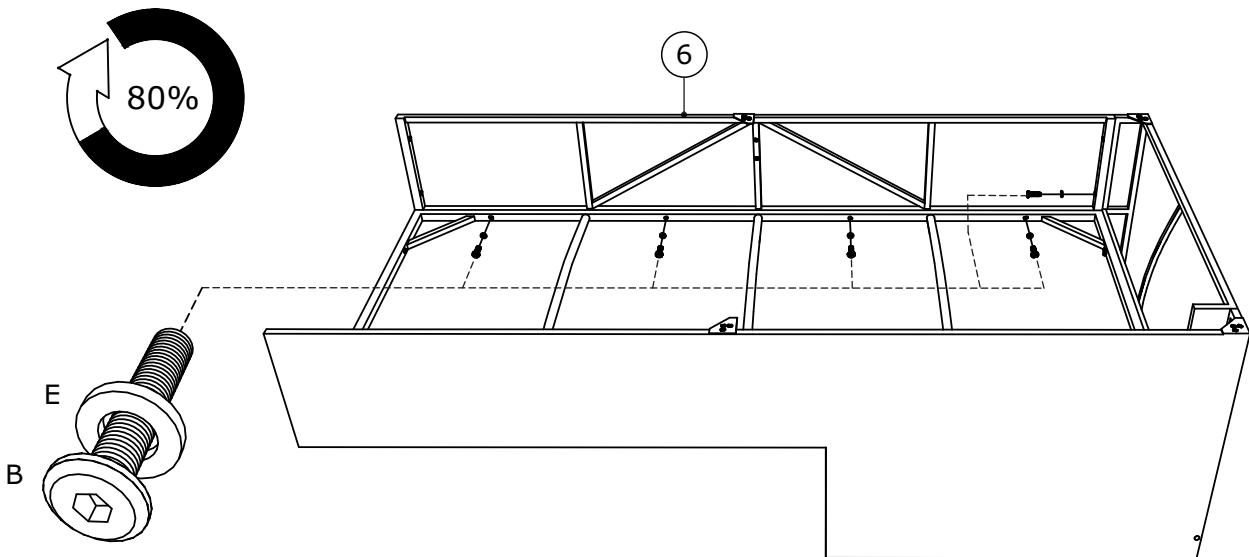

A 	B  M6x15 mm	B  M6x40 mm	C  M6x55 mm	D  M6x110 mm
--	--	--	--	---

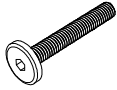
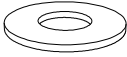
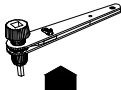

5

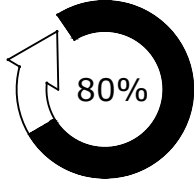
B x 1  M6x40 mm	E x 1  Ø6/Ø14 mm	J x 1  4 mm	
--	---	--	--



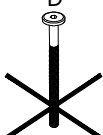

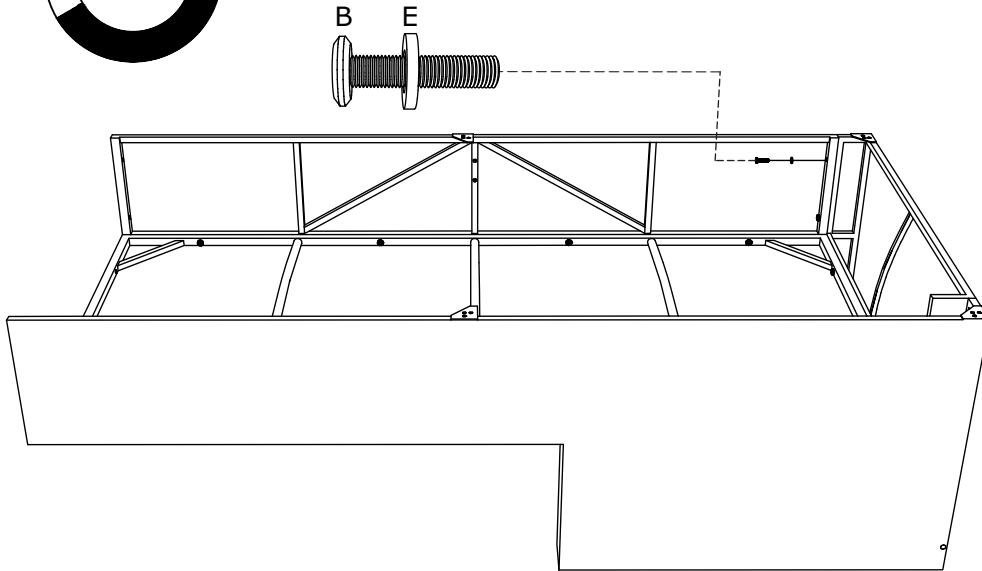

A 	B  M6x15 mm	C  M6x40 mm	D  M6x55 mm M6x110 mm
--	--	--	---

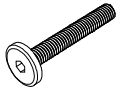
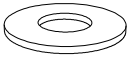
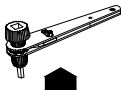

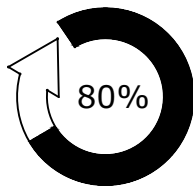
6

B x 4  M6x40 mm	E x 4  Ø6/Ø14 mm	J x 1  4 mm	
--	---	--	--



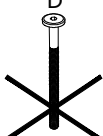

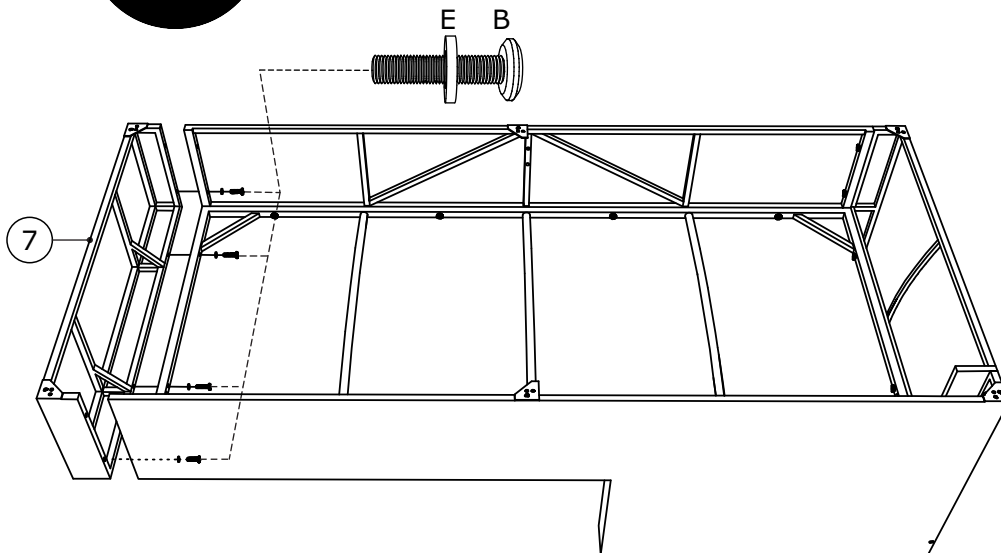

A 	B  M6x15 mm	C  M6x40 mm	D  M6x55 mm M6x110 mm
--	--	--	---

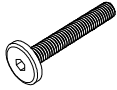
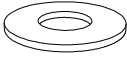
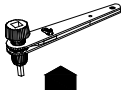

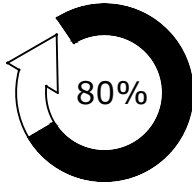
7

B x 2  M6x40 mm	E x 2  Ø6/Ø14 mm	J x 1  4 mm	
--	---	--	--



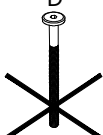

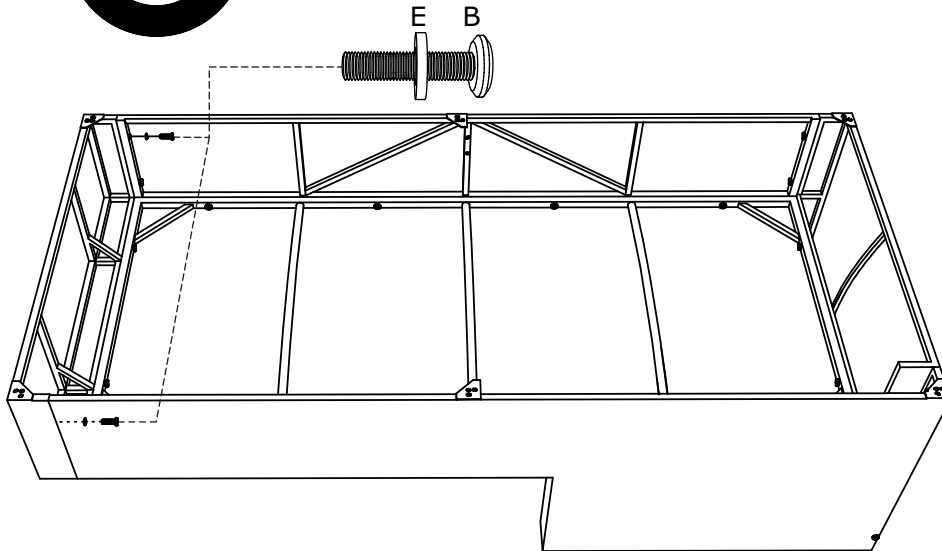
A 	B  M6x15 mm	C  M6x55 mm	D  M6x110 mm
--	--	--	---



8

A x 4  M6x15 mm	J x 1  4 mm		
--	--	--	--

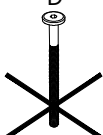
A 	B  M6x40 mm	C  M6x55 mm	D  M6x110 mm
--	--	--	---

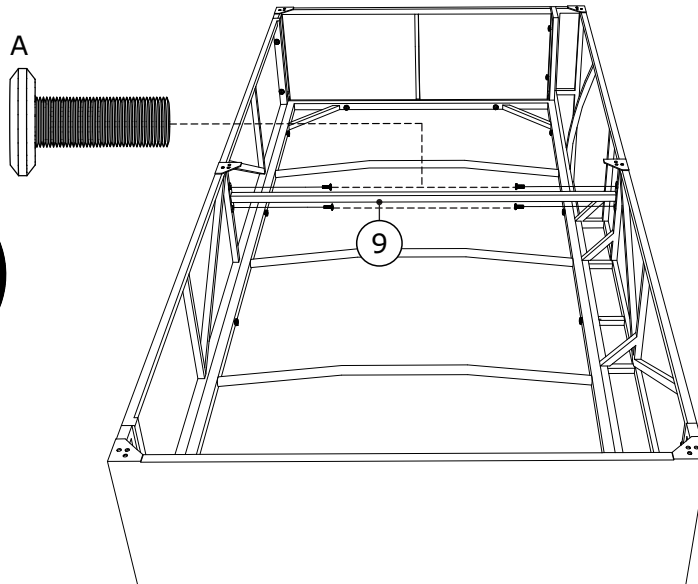
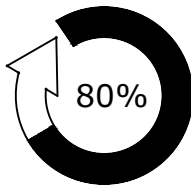

9

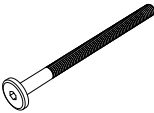
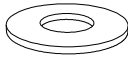
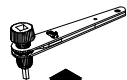
D x 1  M6x110 mm	E x 1  Ø6/Ø14 mm	J x 1  4 mm	
---	---	--	--

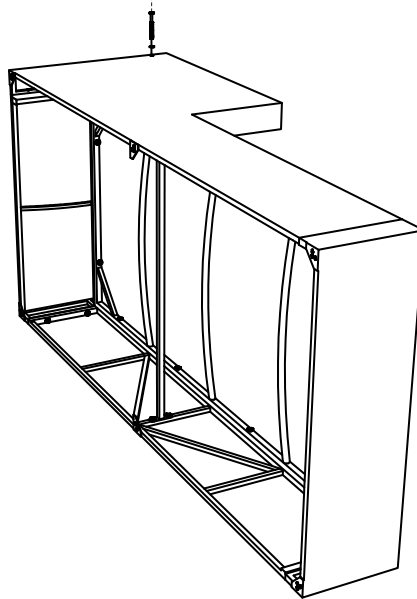
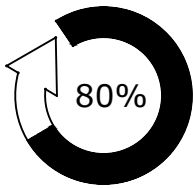
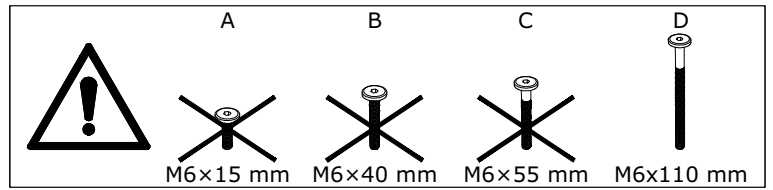





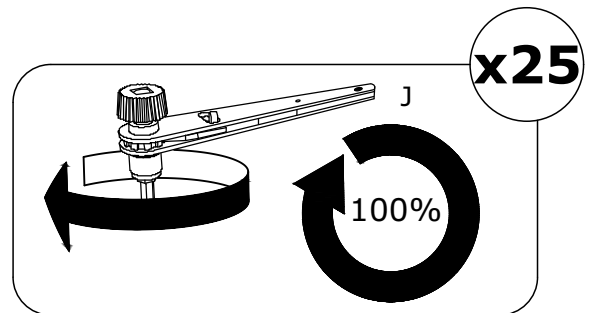
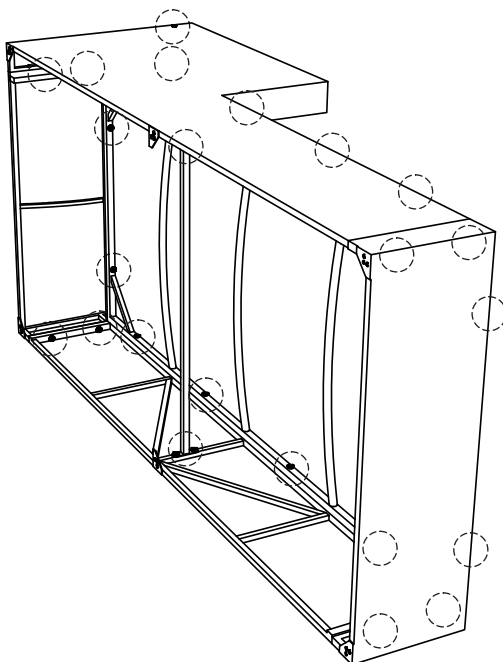

10

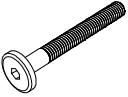
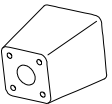
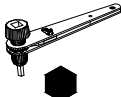
J x 1  4 mm	
--	--



11

<p>C x 6</p>  <p>M6x55 mm</p>	<p>F x 6</p>  <p>45x45x65 mm</p>	<p>J x 1</p>  <p>4 mm</p>	
--	---	--	--

	<p>A</p>  <p>M6x15 mm</p>	<p>B</p>  <p>M6x40 mm</p>	<p>C</p>  <p>M6x55 mm</p>	<p>D</p>  <p>M6x110 mm</p>
---	--	--	--	---

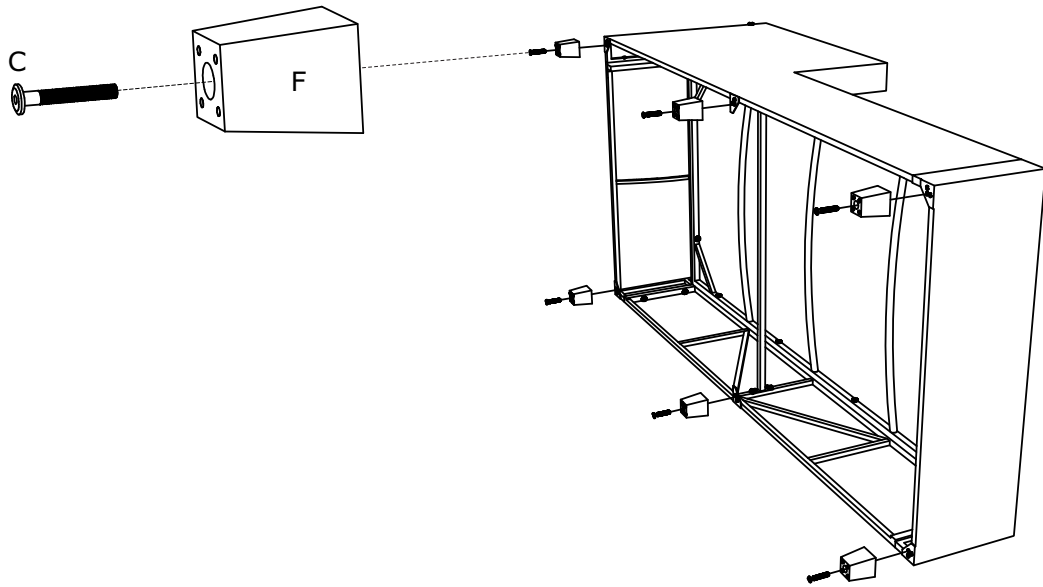



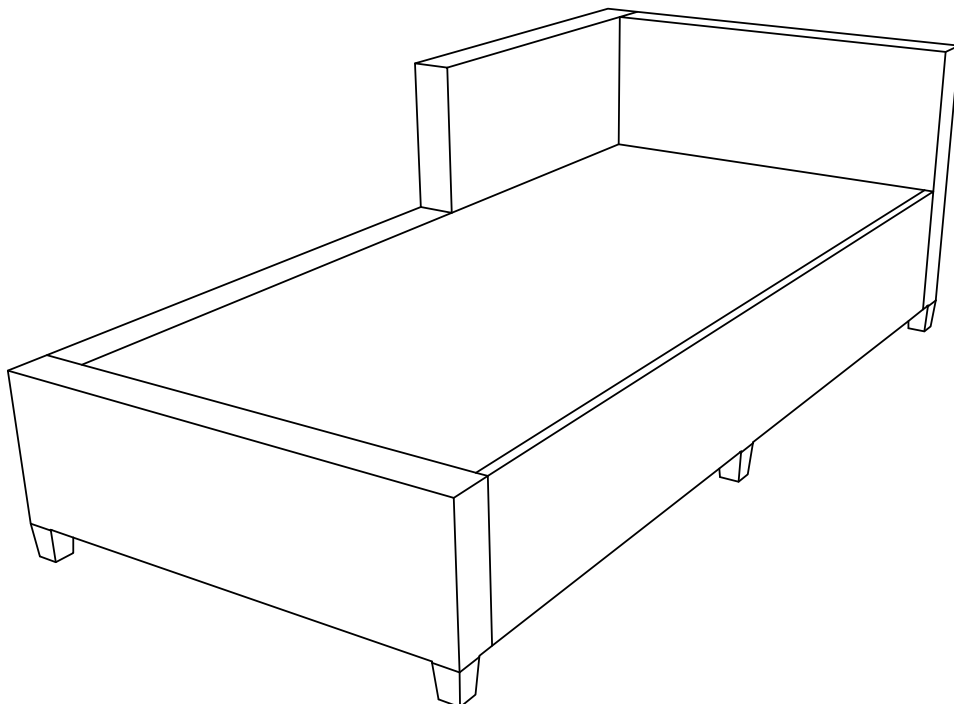

12

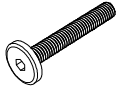
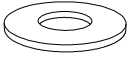
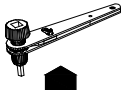

13



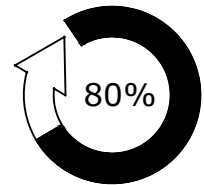
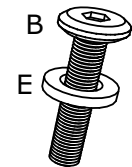
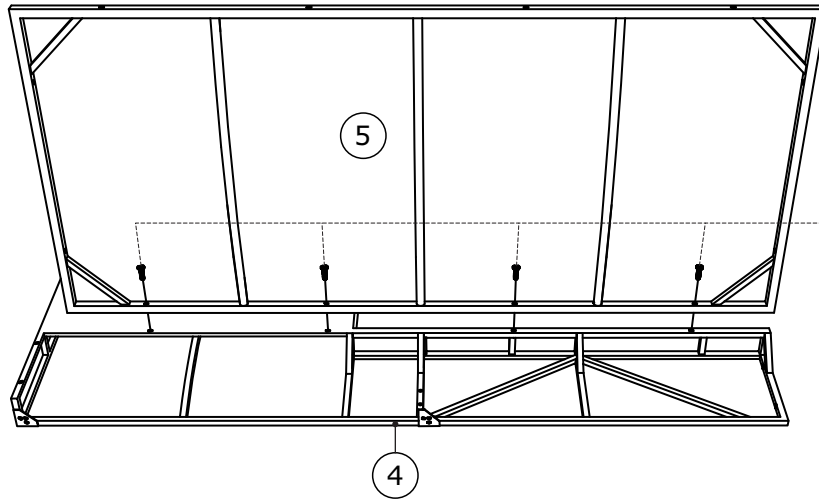

B x 4  M6x40 mm	E x 4  Ø6/Ø14 mm	J x 1  4 mm	
--	---	--	--

A 	B  M6x15 mm	C  M6x55 mm	D  M6x110 mm
--	--	--	---

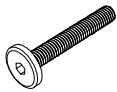
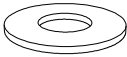
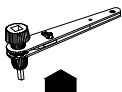

14

B x 2  M6x40 mm	E x 2  Ø6/Ø14 mm	J x 1  4 mm	
--	---	--	--

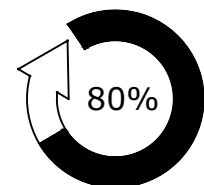
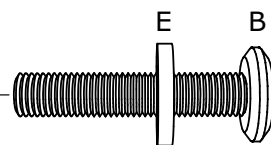
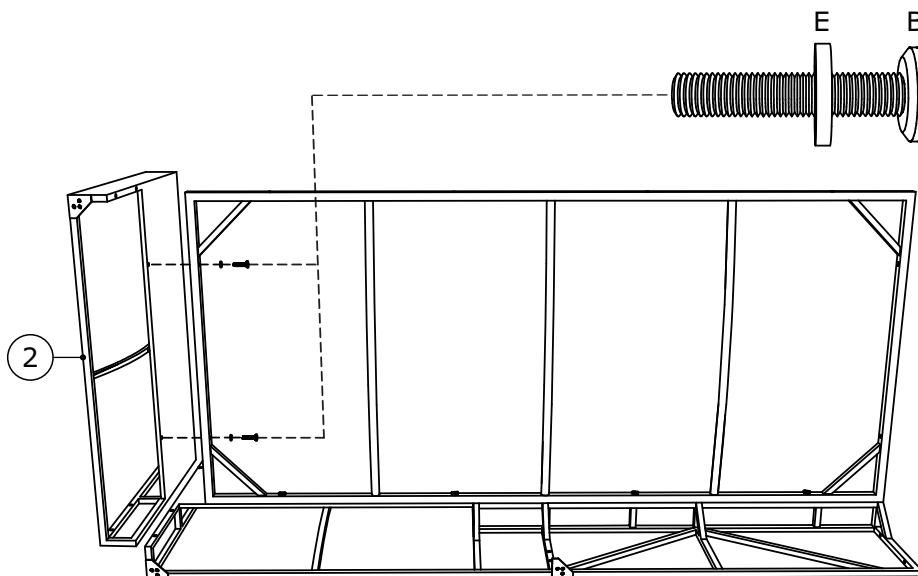

A 	B  M6x15 mm	C  M6x55 mm	D  M6x110 mm
--	--	--	---

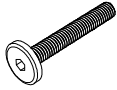
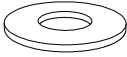
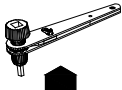

15

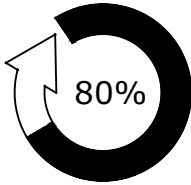
B x 2  M6x40 mm	E x 2  Ø6/Ø14 mm	J x 1  4 mm	
--	---	--	--



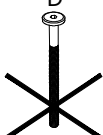

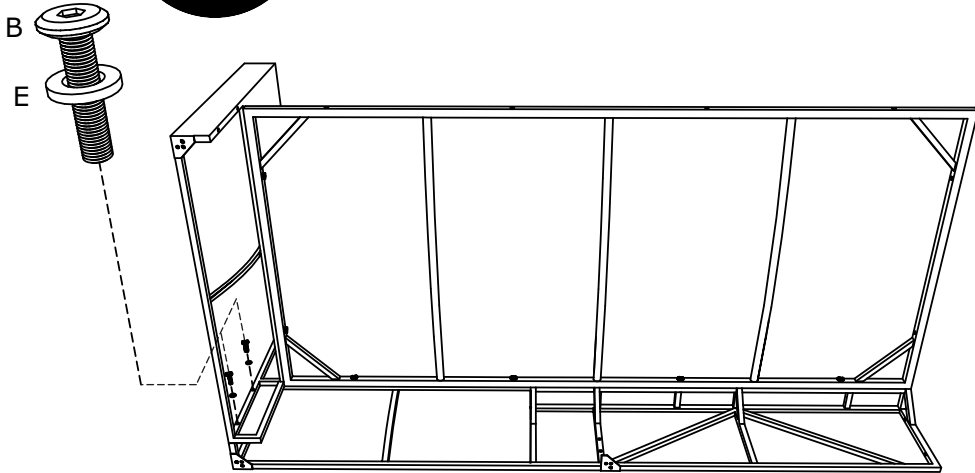
A 	B  M6x15 mm	C  M6x55 mm	D  M6x110 mm
--	--	--	---

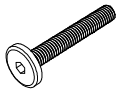
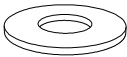
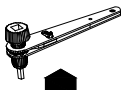

16

B x 5  M6x40 mm	E x 5  Ø6/Ø14 mm	J x 1  4 mm	
--	---	--	--

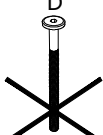

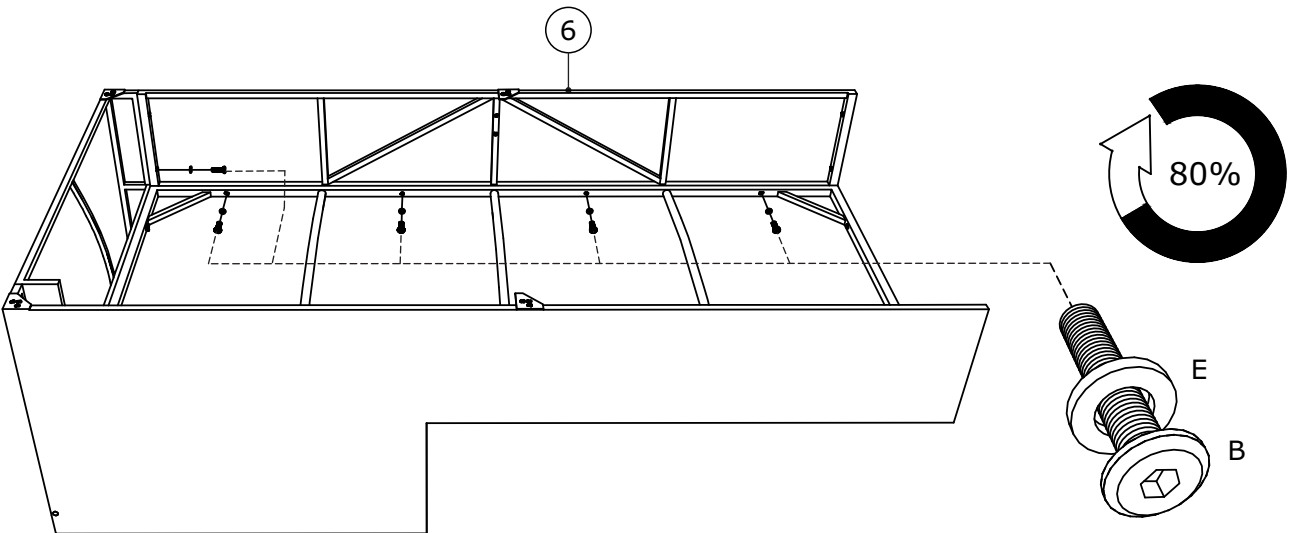

A 	B  M6x15 mm	C  M6x55 mm	D  M6x110 mm
--	--	--	---

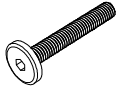
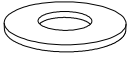
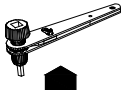

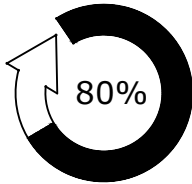
17

B x 1  M6x40 mm	E x 1  Ø6/Ø14 mm	J x 1  4 mm	
--	---	--	--



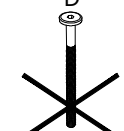

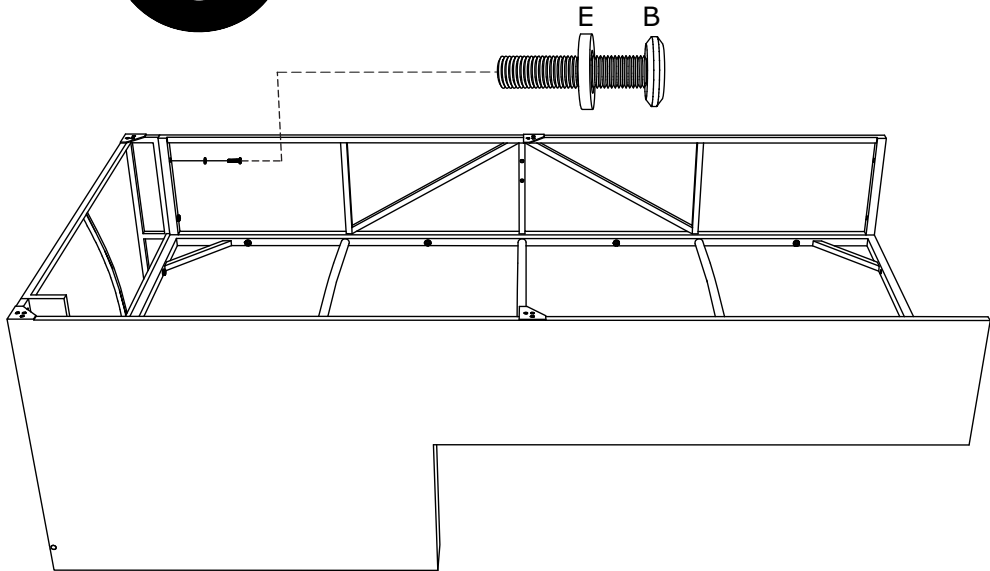

A 	B  M6x15 mm	C  M6x40 mm	D  M6x55 mm	 M6x110 mm
--	--	--	--	--

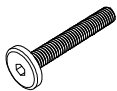
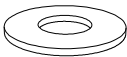
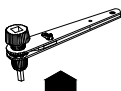

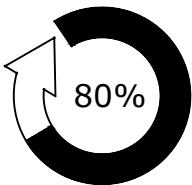
18

B x 4  M6x40 mm	E x 4  Ø6/Ø14 mm	J x 1  4 mm	
--	---	--	--



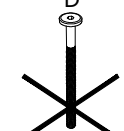

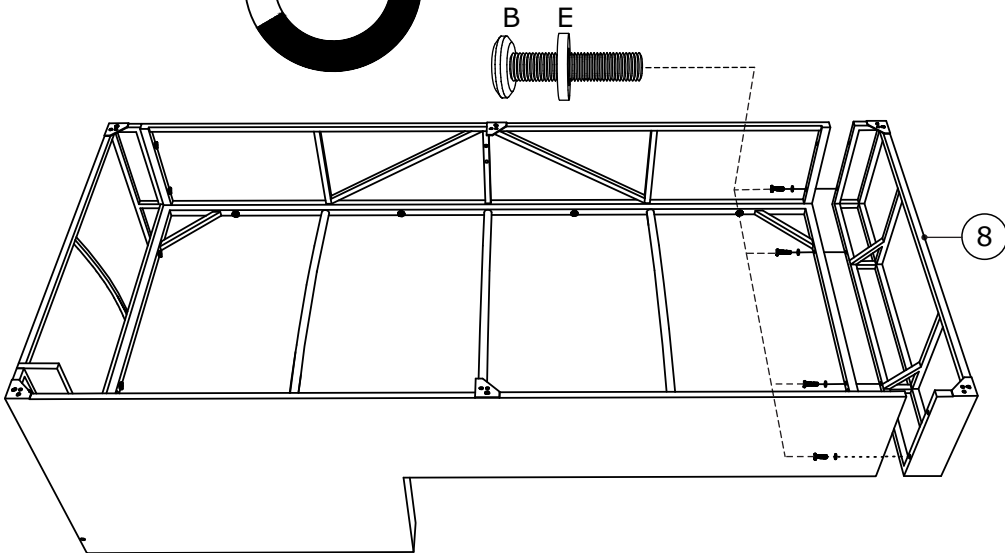

A 	B  M6x15 mm	C  M6x40 mm	D  M6x55 mm	 M6x110 mm
--	--	--	--	--

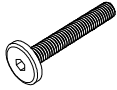
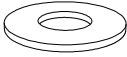
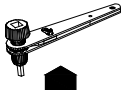

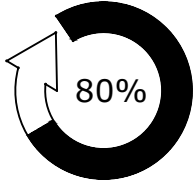
19

B x 2  M6x40 mm	E x 2  Ø6/Ø14 mm	J x 1  4 mm	
--	---	--	--



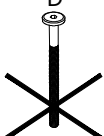

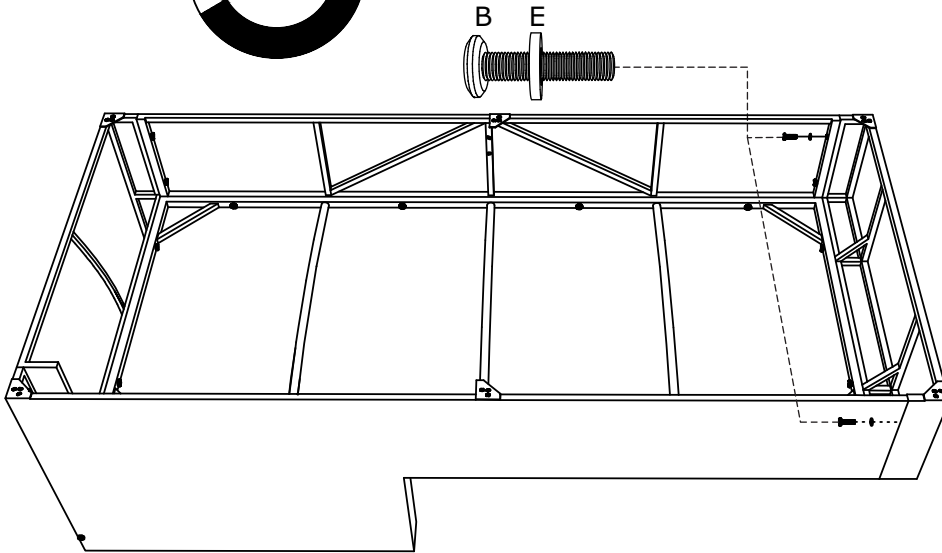
A 	B  M6x15 mm	C  M6x55 mm	D  M6x110 mm
--	--	--	---



20

A x 4  M6x15 mm	J x 1  4 mm	
--	--	--

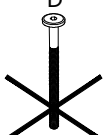
A 	C  M6x55 mm	D  M6x110 mm
---	--	---

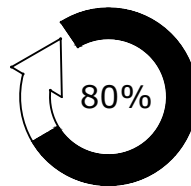
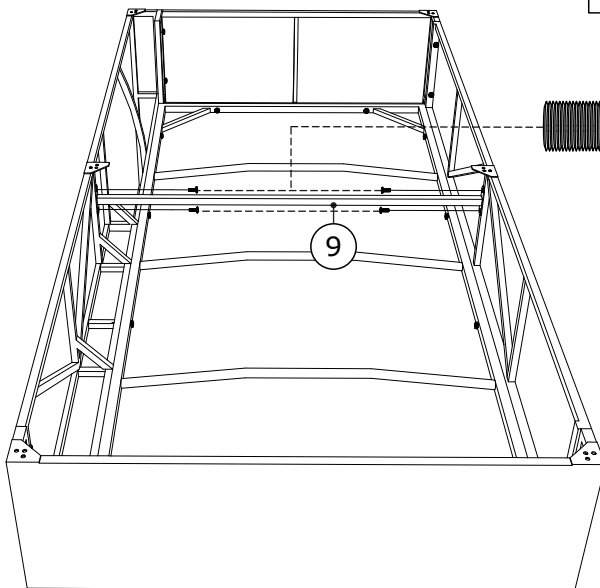

21

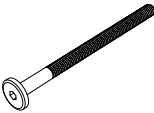
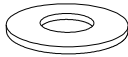
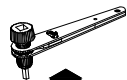
D x 1  M6x110 mm	E x 1  Ø6/Ø14 mm	J x 1  4 mm	
---	---	--	--

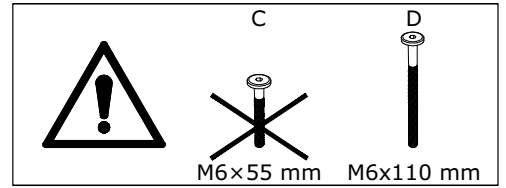
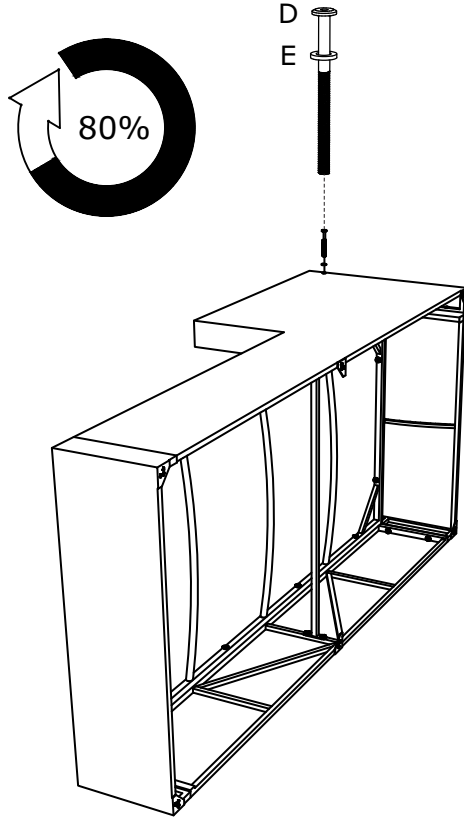

22

J x 1  4 mm	
--	--

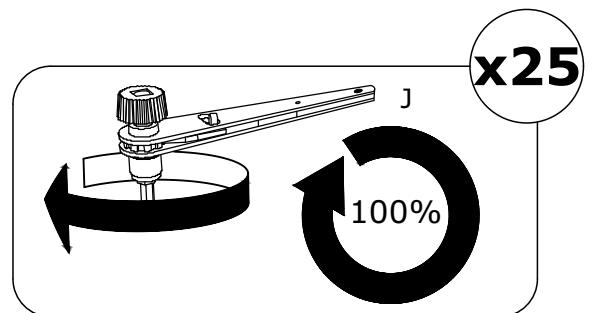
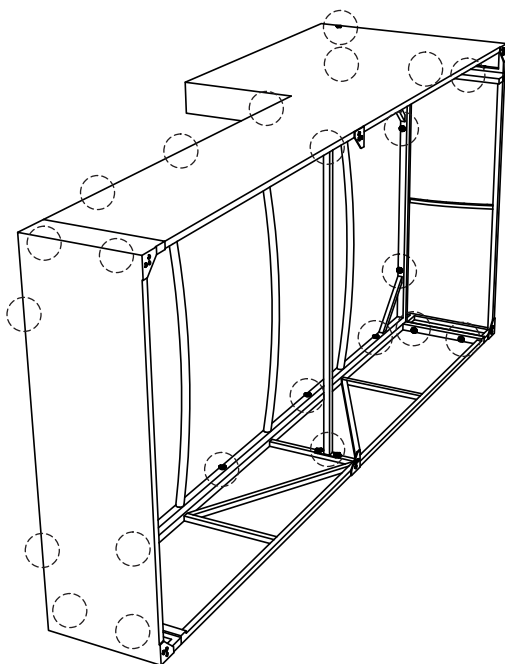

23

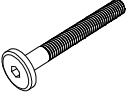
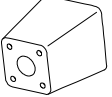
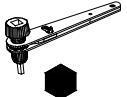
<p>C x 6</p>  <p>M6x55 mm</p>	<p>F x 6</p>  <p>45x45x65 mm</p>	<p>J x 1</p>  <p>4 mm</p>	
--	---	--	--

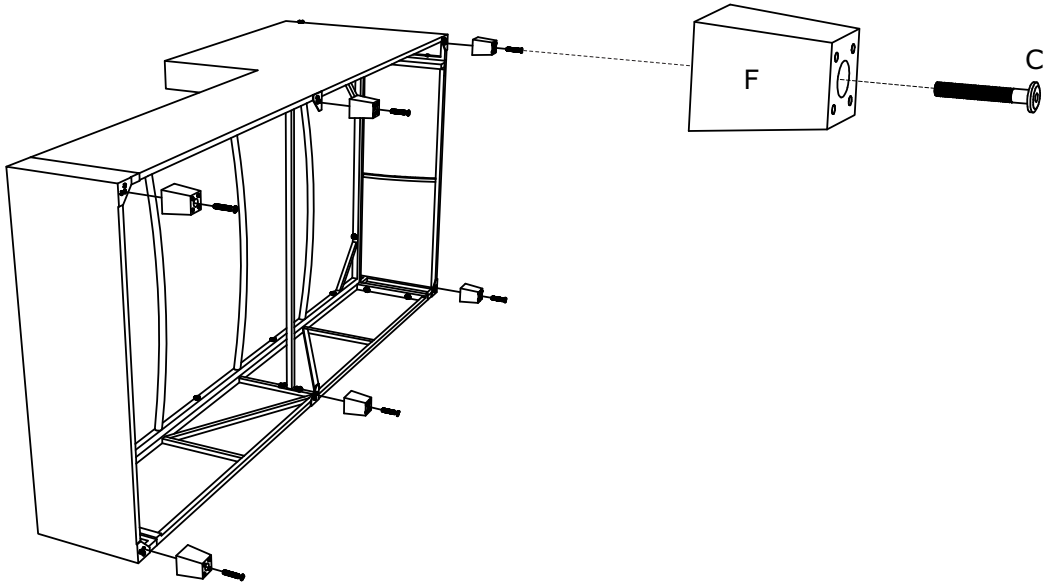

24

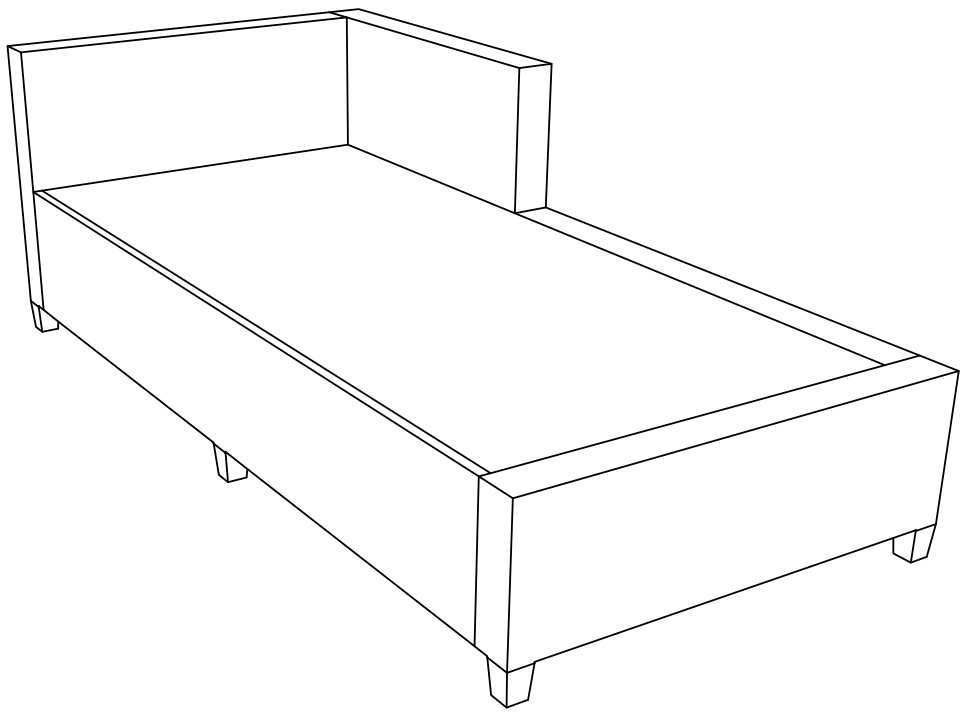

25

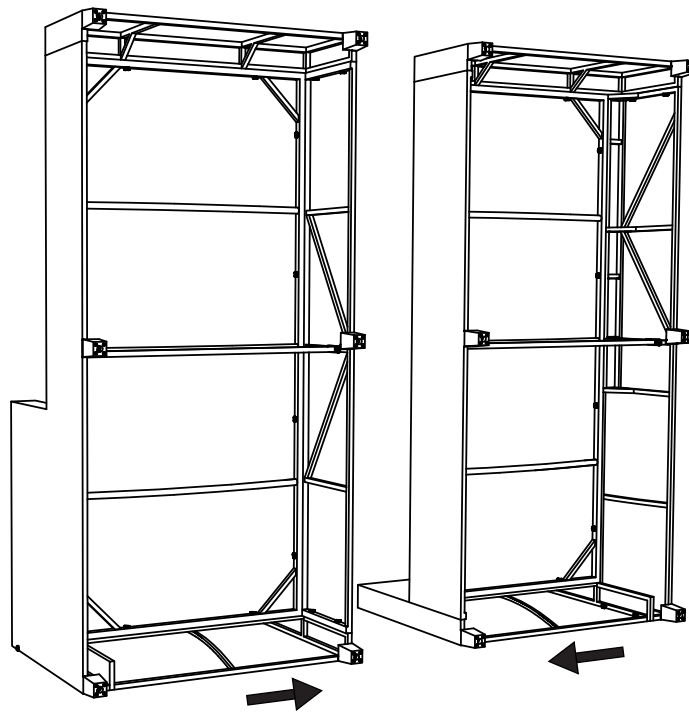

26

G x 3



60x40x30 mm

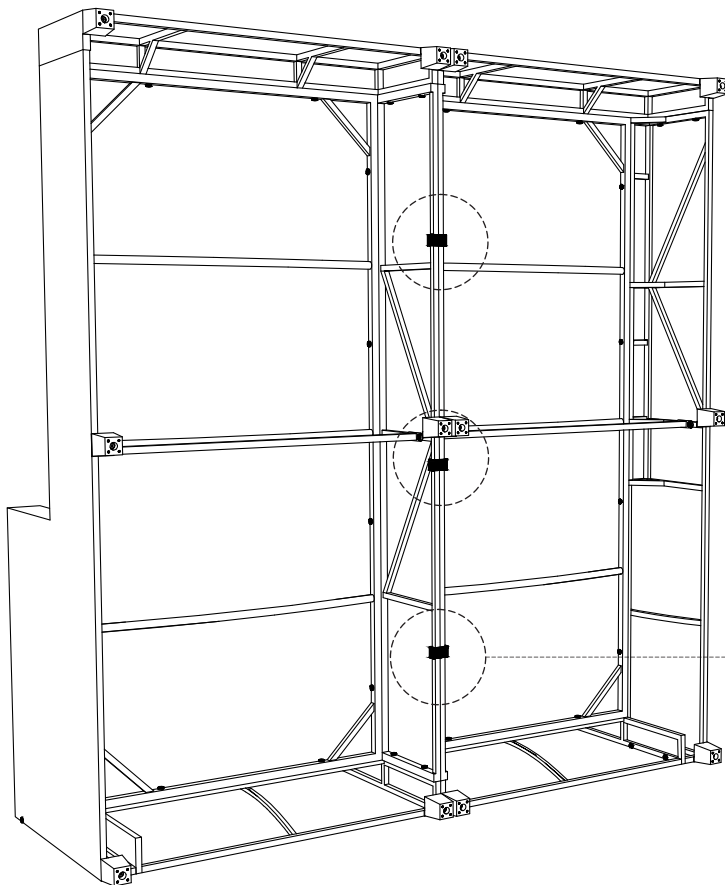

x3

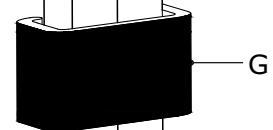

27

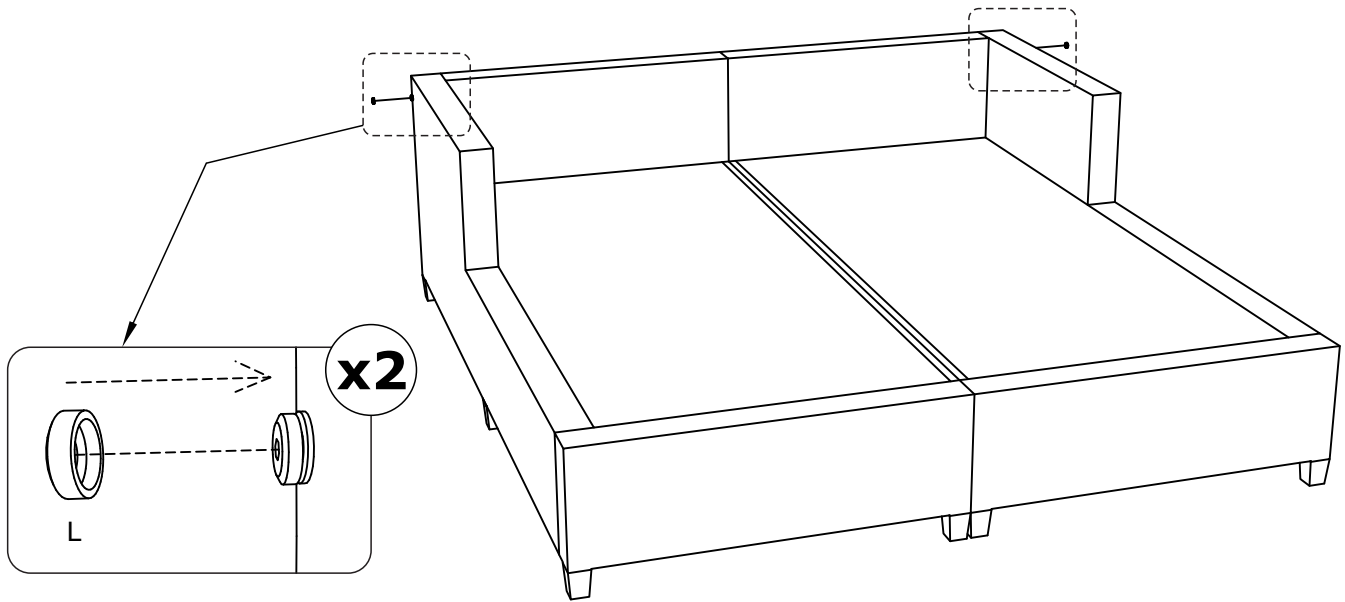

28

